



Apartment Design Guide

Tools for improving the design of
residential apartment development

To view an electronic version in PDF format, visit www.planning.nsw.gov.au

ISBN 978-0-7313-3676-0

© Crown Copyright 2015

NSW Department of Planning and Environment
July 2015

Disclaimer

While every reasonable effort has been made to ensure that this document is correct at the time of printing, the State of New South Wales, its agents and employees, disclaim any and all liability to any person in respect of anything or the consequences of anything done or omitted to be done in reliance or upon the whole or any part of this document.

Copyright Notice

In keeping with Planning and Environment's commitment to encourage the availability of information, you are welcome to reproduce the material that appears in this document for personal, in-house or non-commercial use without formal permission or charge. All other rights are reserved. If you wish to reproduce, alter, store or transmit material appearing in this document for any other purpose, a request for formal permission should be directed to:

NSW Department of Planning and Environment
GPO Box 39
Sydney NSW 2001

You are required to acknowledge that the material is provided by the Department or the owner of the copyright as indicated in this document and to include this copyright notice and disclaimer in any copy. You are also required to acknowledge the author (Planning and Environment) of the material as indicated in this document.

Apartment Design Guide

Tools for improving the design of
residential apartment development



Planning &
Environment

Contents

Introduction

Minister's foreword	7
About this guide	8
How to use this guide	10

Part 1 Identifying the context

1A Apartment building types	16
1B Local character and context	20
1C Precincts and individual sites	24

Part 2 Developing the controls

2A Primary controls	28
2B Building envelopes	29
2C Building height	30
2D Floor space ratio	32
2E Building depth	34
2F Building separation	36
2G Street setbacks	38
2H Side and rear setbacks	40

Part 3 Siting the development

3A Site analysis	44
3B Orientation	48
3C Public domain interface	50
3D Communal and public open space	54
3E Deep soil zones	60
3F Visual privacy	62
3G Pedestrian access and entries	66
3H Vehicle access	68
3J Bicycle and car parking	70

Part 4 Designing the building**Amenity**

4A	Solar and daylight access	78
4B	Natural ventilation	82
4C	Ceiling heights	86
4D	Apartment size and layout	88
4E	Private open space and balconies	92
4F	Common circulation and spaces	96
4G	Storage	100
4H	Acoustic privacy	102
4J	Noise and pollution	104

Configuration

4K	Apartment mix	106
4L	Ground floor apartments	108
4M	Facades	110
4N	Roof design	112
4O	Landscape design	114
4P	Planting on structures	116
4Q	Universal design	118
4R	Adaptive reuse	120
4S	Mixed use	122
4T	Awnings and signage	124

Performance

4U	Energy efficiency	126
4V	Water management and conservation	128
4W	Waste management	130
4X	Building maintenance	132

Part 5 Design review panels

5A	Function of design review panels	137
5B	Membership and establishment	138
5C	Roles and responsibilities	140
5D	Meeting procedures	142
5E	Templates	144

Appendices

Appx 1	Site analysis checklist	150
Appx 2	Pre-development application checklist	152
Appx 3	DA documentation checklist	154
Appx 4	Apartment building example schemes	158
Appx 5	Sunlight access analysis tool	177
	Glossary	178



Minister's foreword

Apartments are an increasingly popular housing choice in New South Wales and Sydney more significantly. In the decade up to 2011, the proportion of Sydney households living in a house fell from 68% to 60% while the share living in apartments rose to almost 30% in that same period. Although a house with a backyard will remain the preference for many, the number of people living in apartments will continue to increase across Sydney and in our regional centres. In fact, the City of Sydney is expecting around 80 per cent of residents to be living in apartments by 2030. With this demand for apartment living growing, the design of this popular housing choice and its potential to improve liveability is more crucial than ever.

The first major policy initiative in New South Wales to lift the quality of apartment design was the introduction of State Environmental Planning Policy No. 65 – Design Quality of Residential Flat Development (SEPP 65) and the Residential Flat Design Code back in 2002.

There have been a number of achievements since the introduction of this policy thirteen years ago. We have seen a shift to well designed, high quality apartment buildings with improved internal amenity and we have seen significant improvements to how apartment developments relate to their neighbourhood. This has also meant the growth of new, well designed apartment based communities surrounded by public transport, shops and services, as well as open spaces that encourage more active lifestyles.

There is no doubt that good apartment design helps to create healthy, safe and liveable communities. Apartments also provide housing choice for those with a range of incomes and lifestyle preferences. We need more and different types of homes as our State's needs change over time.

With this in mind, the New South Wales Government embarked on a review of SEPP 65. Throughout the review one thing was clear – our stakeholders, including councils, industry, practitioners and the community all commended the policy for the positive effect it has had on apartment design in the State.

The review has resulted in amendments to both SEPP 65 and the Residential Flat Design Code, now called the Apartment Design Guide. The name of SEPP 65 has also been amended to update terminology throughout the SEPP and align it with the updated Apartment Design Guide. These amendments have updated the policy based on extensive feedback from our stakeholders and ensure that design quality of apartments is maintained, while promoting housing supply and affordability. The changes introduce greater flexibility into the design process to encourage more innovation, and provide clarity and consistency in the way design issues are dealt with for apartments.

In preparing the Apartment Design Guide, expert advice has been widely sought. I thank our councils, industry partners, organisations and the community who have all contributed to the review.

My vision is to see New South Wales delivering the best apartments in the country. We've been setting the benchmark since SEPP 65 was introduced, with architects striving for innovation in apartment design and contributing to diverse communities. In future, councils and industry partners will continue to work together to create these places, and more great neighbourhoods. Good apartment design is a key factor in delivering quality homes for communities that are light, well ventilated and flexible to suit the many needs of our modern lifestyle. Most importantly, I envisage diverse neighbourhoods and great places for communities to live. Working together, I have no doubt that we can achieve this vision and continue to be the leaders, setting the benchmark for apartment design in Australia.

The Hon. Rob Stokes MP
Minister for Planning

About this guide

What is the Apartment Design Guide

This Apartment Design Guide is a resource to improve the planning and design of residential apartment development in NSW. It updates and replaces the Residential Flat Design Code introduced in 2002.

The Apartment Design Guide is to be used in conjunction with *State Environmental Planning Policy No 65 – Design Quality of Residential Apartment Development* (SEPP 65) which sets out the NSW Government's policy direction for residential apartment development in NSW.



Aims of the Guide

This Apartment Design Guide will help to achieve better design and planning for residential apartment development, by providing benchmarks for designing and assessing these developments.

It is designed to:

- deliver better quality design for buildings that respond appropriately to the character of the area, landscape setting and surrounding built form
- improve liveability through enhanced internal and external apartment amenity, including better layout, apartment depth and ceiling heights, solar access, natural ventilation and visual privacy
- deliver improved sustainability through better traffic and transport solutions, greater building adaptability and robustness, improved energy efficiency and water sensitive urban design
- improve the relationship of apartments to the public domain including streets, lanes and parks
- deliver design guidance and assist in the provision of more diverse housing mix and choice
- support councils in developing planning controls and master plans through improved guidance.

The Guide has responded to challenges, advances and innovations across a range of social, economic, environmental and sustainable development fields as well as aesthetic and technical changes and opportunities.



Photo: Brett Boardman

Statutory relationship to SEPP 65

There is a close and integrated relationship between this Apartment Design Guide and SEPP 65.

SEPP 65 sets a consistent policy direction for residential apartment development in NSW and provides a uniform state-wide framework for more detailed planning guidance. It has a statutory effect on development and as a consequence may modify or supplement the provisions of state environmental planning policies, local environmental plans (LEP) and development control plans (DCP).

Although this document is a guide, SEPP 65 refers to some parts of the Apartment Design Guide that must be applied when assessing development applications. Objectives, design criteria and design guidance in Parts 3 and 4 of this Apartment Design Guide that are referred to in SEPP 65 will prevail over any inconsistent DCP control. Parts 3 and 4 set out objectives, design criteria and design guidance for the siting, design and amenity of residential apartment development.

Certain design criteria referred to in SEPP 65 cannot be used as a reason to refuse a development application, if complied with.

SEPP 65 establishes nine design quality principles to be applied in the design and assessment of residential apartment development. This Apartment Design Guide provides greater detail on how residential development proposals can meet these principles through good design and planning practice.

Residential apartment development

SEPP 65 and the Apartment Design Guide apply to residential flat buildings, shop top housing and the residential component of mixed use developments. They apply to buildings that are three or more storeys and that have four or more dwellings where the development consists of the:

- erection of a new building
- substantial redevelopment or refurbishment of an existing building
- conversion of an existing building to a residential flat building.



How to use this guide

Who is this Apartment Design Guide for?

The Apartment Design Guide provides consistent planning and design standards for residential apartments across NSW. It has been prepared to:

- be a tool for developers, planners, urban designers, architects, landscape architects, builders and other professionals when designing apartments and preparing a development application
- assist planning professionals in local and state government with strategic planning and in the preparation of local controls, design guidelines and the assessment of development proposals.

The Guide will also help to inform the community on what is required to achieve good design and planning practice for residential apartments.



Structure of the Apartment Design Guide

The Apartment Design Guide addresses the design of residential apartment development at the site and individual building scale. It includes the following parts:

Part 1 - Identifying the context

This part introduces generic apartment building types to inform appropriate site, block and building design responses at a strategic level. It outlines the importance of understanding the context, setting, local character, size and configuration of a development site. It is to be used primarily during the design stage of a development and during the strategic planning process when preparing planning controls.

Part 2 - Developing the controls

This part explains the application of building envelopes and primary controls including building height, floor space ratio, building depth, separation and setbacks. It provides tools to support the strategic planning process when preparing planning controls.

Part 3 - Siting the development

This part provides guidance on the design and configuration of apartment development at a site scale. It outlines how to relate to the immediate context, consider the interface to neighbours and the public domain, achieve quality open spaces and maximise residential amenity. It is to be used during the design process and in the preparation and assessment of development applications.

Part 4 - Designing the building

This part addresses the design of apartment buildings in more detail. It focuses on building form, layout, functionality, landscape design, environmental performance and residential amenity. It is to be used during the design process and in the preparation and assessment of development applications.

Part 5 – Design review panels

This part explains the role of design review panels in the development assessment process, outlines administrative procedures and provides templates for the successful operation of a panel. It is to be used by councils to administer design review panels at all relevant stages of the development process.

Appendices

This part includes checklists for information required at different stages in the planning process.

Achieving the objectives

Parts 3 and 4 of the Apartment Design Guide provide objectives, design criteria and design guidance for the siting, design and amenity of apartment development. Each topic area is structured to provide the user with:

1. a **description** of the topic and an explanation of its role and importance
2. **objectives** that describe the desired design outcomes
3. **design criteria** that provide the measurable requirements for how an objective can be achieved.
4. **design guidance** that provides advice on how the objectives and design criteria can be achieved through appropriate design responses, or in cases where design criteria cannot be met.

The key to working with Parts 3 and 4 is that a development needs to demonstrate how it meets the objective and design criteria. The design criteria set a clear measurable benchmark for how the objective can be practically achieved. If it is not possible to satisfy the design criteria, applications must demonstrate what other design responses are used to achieve the objective and the design guidance can be used to assist in this.

Not all sections within Parts 3 and 4 specify design criteria. In these instances the design guidance should be referred to when demonstrating how an objective is being achieved.

SEPP 65 sets out certain matters in Parts 3 and 4 that apply in place of development control plans. This removes uncertainty when there are conflicting provisions for these matters in development control plans.



Objective

outcomes to be achieved by residential apartment development

Objective 3D-1
An adequate area of communal open space is provided to enhance residential amenity and to provide opportunities for landscaping

Design criteria

1. Communal open space has a minimum area equal to 25% of the site (see figure 3D.3)
2. Developments must achieve a minimum of 50% direct sunlight to the principal usable part of the communal open space for a minimum of 2 hours between 9 am and 3 pm on 21 June (mid winter)

Design guidance

Communal open space should be consolidated into a well designed, easily identified and usable area

Communal open space should have a minimum dimension of 3m, and larger developments should consider greater dimensions

Communal open space should be co-located with deep soil areas

Design criteria

measurable criteria to achieve the objective for residential apartment development

Design guidance

design advice on how the objective can be achieved through particular design approaches

How to use this guide

Development application and assessment process

The Apartment Design Guide provides a resource for pre-development application (pre-DA) discussions between applicants and consent authorities. The guide advocates meetings early on in the design and planning process to focus on how to ensure the best built form configuration, siting and design outcomes.

Appendix 2 of this guide provides recommendations and a list of suggested documents for pre-DA discussions.

Development application submission requirements for residential apartment developments are set within the *Environmental Planning and Assessment Regulation 2000*. Residential apartment developments also need to meet the requirements set out in SEPP 65, which includes a suite of nine design quality principles.

The checklist in Appendix 3 of this guide elaborates on the required information for development application submissions and explains the purpose of each item in more detail.

The SEPP 65 design quality principles act as an important link between the provisions of SEPP 65 and the more detailed design guidance contained in this Apartment Design Guide.

Application of the design quality principles

The SEPP 65 design quality principles must be considered by design professionals when designing residential apartment development, by design review panels when giving advice on proposals and by consent authorities.



Design Quality Principles (SEPP 65)

Principle 1: Context and Neighbourhood Character

Good design responds and contributes to its context. Context is the key natural and built features of an area, their relationship and the character they create when combined. It also includes social, economic, health and environmental conditions.

Responding to context involves identifying the desirable elements of an area's existing or future character. Well designed buildings respond to and enhance the qualities and identity of the area including the adjacent sites, streetscape and neighbourhood. Consideration of local context is important for all sites, including sites in established areas, those undergoing change or identified for change.

Principle 2: Built Form and Scale

Good design achieves a scale, bulk and height appropriate to the existing or desired future character of the street and surrounding buildings.

Good design also achieves an appropriate built form for a site and the building's purpose in terms of building alignments, proportions, building type, articulation and the manipulation of building elements. Appropriate built form defines the public domain, contributes to the character of streetscapes and parks, including their views and vistas, and provides internal amenity and outlook.

Principle 3: Density

Good design achieves a high level of amenity for residents and each apartment, resulting in a density appropriate to the site and its context.

Appropriate densities are consistent with the area's existing or projected population. Appropriate densities can be sustained by existing or proposed infrastructure, public transport, access to jobs, community facilities and the environment.

Principle 4: Sustainability

Good design combines positive environmental, social and economic outcomes. Good sustainable design includes use of natural cross ventilation and sunlight for the amenity and liveability of residents and passive thermal design for ventilation, heating and cooling reducing reliance on technology and operation costs. Other elements include recycling and reuse of materials and waste, use of sustainable materials, and deep soil zones for groundwater recharge and vegetation.

Principle 5: Landscape

Good design recognises that together landscape and buildings operate as an integrated and sustainable system, resulting in attractive developments with good amenity. A positive image and contextual fit of well designed developments is achieved by contributing to the landscape character of the streetscape and neighbourhood.

Good landscape design enhances the development's environmental performance by retaining positive natural features which contribute to the local context, co-ordinating water and soil management, solar access, micro-climate, tree canopy, habitat values, and preserving green networks. Good landscape design optimises usability, privacy and opportunities for social interaction, equitable access, respect for neighbours' amenity, provides for practical establishment and long term management.

Principle 6: Amenity

Good design positively influences internal and external amenity for residents and neighbours. Achieving good amenity contributes to positive living environments and resident well being.

Good amenity combines appropriate room dimensions and shapes, access to sunlight, natural ventilation, outlook, visual and acoustic privacy, storage, indoor and outdoor space, efficient layouts and service areas, and ease of access for all age groups and degrees of mobility.

Principle 7: Safety

Good design optimises safety and security, within the development and the public domain. It provides for quality public and private spaces that are clearly defined and fit for the intended purpose. Opportunities to maximise passive surveillance of public and communal areas promote safety.

A positive relationship between public and private spaces is achieved through clearly defined secure access points and well lit and visible areas that are easily maintained and appropriate to the location and purpose.

Principle 8: Housing Diversity and Social Interaction

Good design achieves a mix of apartment sizes, providing housing choice for different demographics, living needs and household budgets.

Well designed apartment developments respond to social context by providing housing and facilities to suit the existing and future social mix. Good design involves practical and flexible features, including different types of communal spaces for a broad range of people, providing opportunities for social interaction amongst residents.

Principle 9: Aesthetics

Good design achieves a built form that has good proportions and a balanced composition of elements, reflecting the internal layout and structure. Good design uses a variety of materials, colours and textures.

The visual appearance of well designed apartment development responds to the existing or future local context, particularly desirable elements and repetitions of the streetscape.

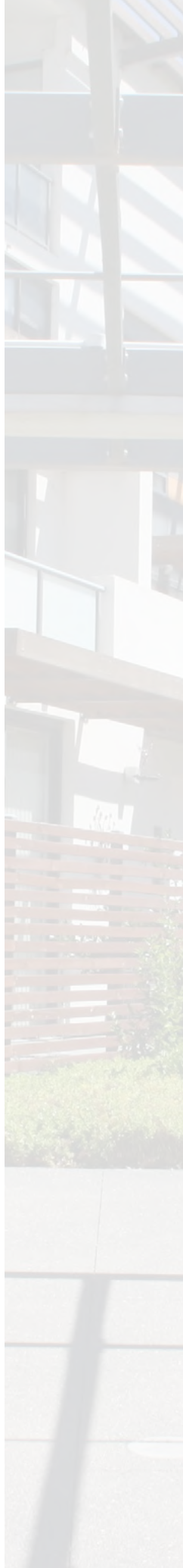



Part 1

Identifying the context

- 1A Apartment building types
- 1B Local character and context
- 1C Precincts and individual sites

This part introduces generic apartment building types to inform appropriate site, block and building design responses at a strategic level. It outlines the importance of understanding the context, setting, local character, size and configuration of a development site. It is to be used primarily during the design stage of a development and during the strategic planning process when preparing planning controls

1A Apartment building types

Apartment development occurs in a variety of arrangements, configurations and types. Apartments can occupy different sized lots from large redevelopment areas to small infill sites, can consist of a mix of building types or uses and be situated in suburban, transitional or inner city locations.

The generic apartment building types in this section share common three dimensional and organisational characteristics and provide a high level overview of apartment development. They can be used during the strategic planning phase to:

- determine the appropriate scale of future built form
- communicate the desired character of an area
- assist when testing envelope and development controls to achieve high amenity and environmental performance of future buildings.

Building types can be adapted to fit specific urban contexts. A particular site configuration may be suited to accommodate a mix of types or uses. In larger developments multiple building types may apply and provide more housing choice and design variety.

The apartment building types in this section include:

- narrow infill apartments
- row apartments
- shop top apartments
- courtyard apartments
- perimeter block apartments
- tower apartments
- hybrid developments.

A series of examples representing these building types in more detail is provided in Appendix 4 of this guide.

Narrow infill apartments



Narrow infill apartment types are suited to narrow, deep lots. The design needs to consider privacy impacts on neighbours

Narrow infill apartments are typically two to three storey walk-up apartments (stairs only) or buildings with three to five levels and a lift. They are a response to the dimension of traditional residential lot sizes in suburban areas in NSW which are narrow and deep, and are often surrounded by a combination of detached houses and flat buildings from previous eras.

Privacy impacts along side and rear boundaries to neighbouring properties need to be carefully managed as achieving minimum building separation can be a challenge. This building type is best used when:

- a narrow lot width or frontage results in a building envelope oriented perpendicular to the street frontage
- amalgamation opportunities of properties in the area are constrained.



Row apartments



Row apartments are a modular building type, highly adaptable and able to respond well to sloping sites

Row apartments are generally well suited to both urban and suburban contexts. They are characterised by a limited number of units arranged around an access core and can be single buildings or a series of building modules. This building type is best used when:

- smaller building footprints are desirable
- live and work apartments or commercial/retail uses are encouraged at the ground floor level
- continuation of the street edge is desirable
- a vertical rhythm reinforcing existing subdivision or building patterns is desirable
- rear landscape areas are desired including keeping existing significant trees
- built form needs to step down the street to respond to a slope.

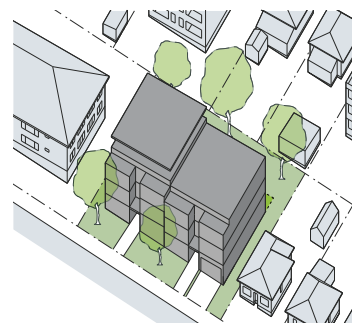
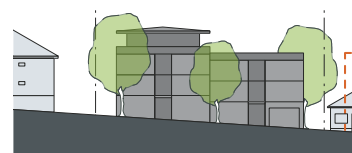

Shop top apartments



Shop top apartments are best suited to main streets and centres that require active retail or commercial frontages

Shop top apartments are mixed use residential buildings often located in established centres, along main streets or close to public transport hubs. They can be small infill or larger developments where the ground floor is occupied by retail or commercial uses. Shop top apartments typically range between two and six storeys and are best used when:

- increased residential uses are desired in established retail and commercial areas
- the context is a traditional main street
- zero setbacks to side boundary walls are possible or desired
- active frontages such as retail tenancies are desired at street level
- pedestrian activity on the street is desired
- rear lane access is available.

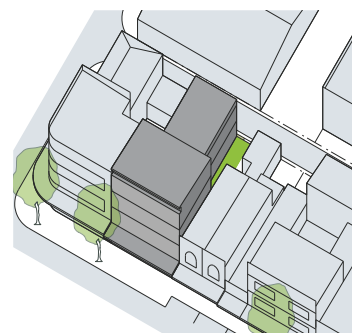
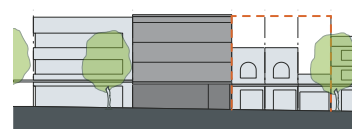

1A Apartment building types

Courtyard apartments



Courtyard apartments are able to fit and respond to a wide range of lot sizes, slopes, orientations and contexts

Courtyard apartments provide a centralised open space area, generally range between three and six storeys in height and are suitable in both urban and suburban settings. Their configuration depends on the context and site orientation. Courtyard apartments are a highly adaptable building type and are best used when:

- located on corner sites or sites with two or more public frontages
- located on sloping sites
- a landscaped street character is desired (by orienting the courtyard to the street)
- an urban character to the street is desired (by creating a street wall edge and orienting the courtyard to the rear)
- there is a predominant aspect or outlook.

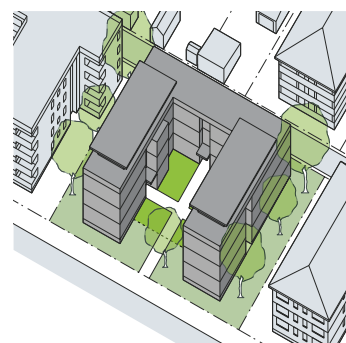
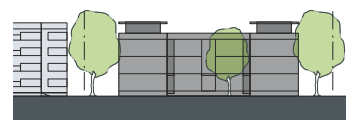

Perimeter block apartments



Perimeter block apartments define the street edge and achieve comparably high urban densities

Perimeter block apartments are suited to urban areas and are often integrated into street blocks. This building type is a key component of most European cities and its compact form achieves comparably high urban densities.

Typically, perimeter block apartments have elongated plans and apartments are generally arranged along a corridor, with a single or multiple cores depending on the building length. They range from four to nine storeys and are best used when:

- an increase in residential density is desired
- a clear definition and continuous street wall edge is desired
- active frontages with commercial and/or retail uses are encouraged at lower levels (see shop top apartment building type)
- towers and tall buildings are not desired.

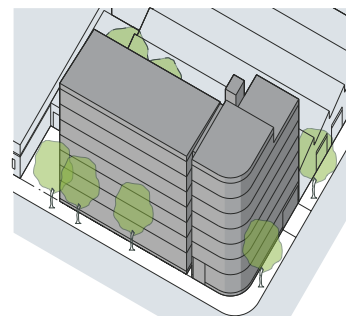
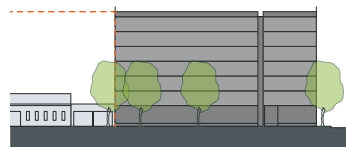

Tower apartments



In commercial centres, tower apartment types are often combined with a podium of four to eight storeys

Towers are suited to central business districts, major centres and urban renewal areas. This building type can be freestanding or combined with block developments (podiums). The location and siting needs to reflect environmental considerations such as wind, overshadowing and visual impacts on surrounding properties and the public domain. Tower apartments are typically more than nine storeys and best used when:

- located in dense urban areas
- other towers exist in the surrounding context
- an area requires greater density than can be delivered by perimeter block buildings
- a strong vertical form or landmark is desired.

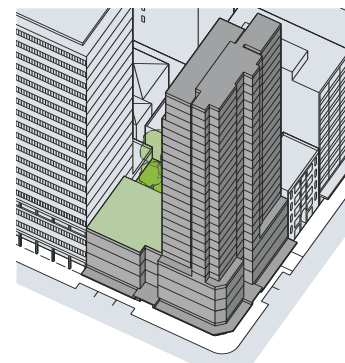
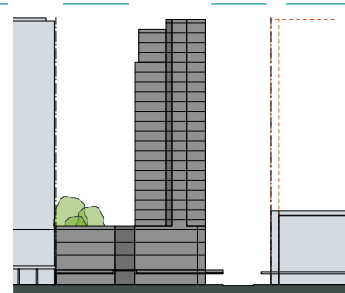

Hybrid developments



Hybrid development types can respond to varying site conditions and achieve interface and future character outcomes

Hybrid developments combine different uses or building types in one development. They can incorporate community facilities and larger commercial or retail components, such as offices or a supermarket.

Hybrid developments are particularly relevant for larger sites that need to respond to a change in building form and scale within the adjacent context. This approach is best used when:

- located on large and/or irregular shaped sites
- a combination of uses is desired to support active urban areas or centres
- greater diversity of apartment types is desired
- a development needs to address two or more streets with different scales and/or characters.

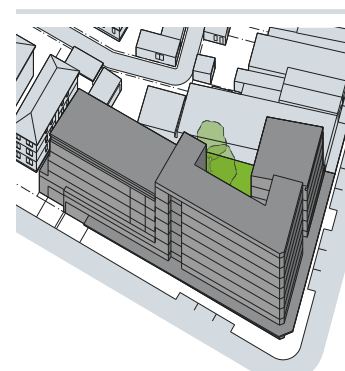
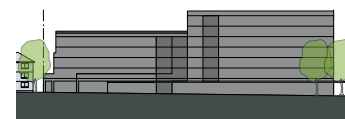

1B Local character and context



Figure 1B.1 Photographs help to communicate the desired future character or future 'look and feel' of an area or development

Good design responds and contributes to its context. Context is everything that has a bearing on an area and comprises its key natural and built features. Context also includes social, economic and environmental factors.

Understanding the context means understanding how the inter-relationships between all these factors, including between the local area and the region, will impact on the area over time.

The process of defining the context's setting and scale has direct implications for design quality of apartments. It establishes the parameters for individual development and how new buildings should respond to and enhance the quality and identity of an area.

Desired future character

The desired future character can vary from preserving the existing look and feel of an area to establishing a completely new character based on different uses, street patterns, subdivisions, densities and typologies.

Establishing the desired future character is determined through the strategic planning process in consultation with the community, industry and other key stakeholders. Understanding the context during this process is crucial to support change and determine appropriate building types and planning controls.

Common settings

The planning process establishes the appropriate location for residential apartment development by determining land use and density in proximity to transport, employment, services, land form and environmental features. Within this framework, the specific characteristics of a place or its setting will inform design decisions. Common settings for residential flat buildings include:

- strategic centres
- local centres
- urban neighbourhoods
- suburban neighbourhoods.

Strategic centres

Strategic centres are characterised by an established commercial core with a full range of services, taller buildings and a network of retail and commercial streets with active frontages.

Considerations for residential apartment development in strategic centres include complex relationships with adjacent buildings, impact of taller building types, privacy between commercial and residential uses, parking demand, high site coverage, limited deep soil, reliance on quality public streets and places and overshadowing.

Local centres

Local centres are typically characterised by an established main street. In larger local centres, retail and commercial uses are distributed around the main street or across a small network of streets defining the core. In smaller local centres, the main street or shopping strip is surrounded by residential uses.

Considerations for residential apartment development in local centres include shop top housing, high site coverage, narrow site frontages, heritage, relationship with adjacent low density residential uses and multiple small lot land ownership requiring amalgamation to support changing use and density.

Urban neighbourhoods

Urban neighbourhoods are often located within walking distance of centres. Established urban neighbourhoods may be characterised by existing residential flat buildings ranging from three storey walk-ups to eight storey perimeter blocks or towers. Other urban neighbourhoods may be transitioning from low density residential and/or a mix of larger format commercial and light industrial use.

Considerations for residential apartment development in these settings include overshadowing, amenity and privacy impacts between existing and future buildings, open space patterns, existing vegetation, demand for new public domain elements, variety of lot sizes and shapes and changing streetscape and scale.



Figure 1B.2 The location of residential flat buildings is determined by factors such as neighbourhood character, accessibility to transport, jobs and services and environmental considerations

Suburban neighbourhoods

Suburban neighbourhoods are typically characterised by detached housing in a landscaped setting.

Considerations for residential apartment development in suburban neighbourhood settings include relationships and interface with existing houses, appropriateness of apartment buildings compared to other forms of medium density housing (such as terraces or townhouses), landscape setting, existing significant trees and the pattern of front and rear gardens.

1B Local character and context

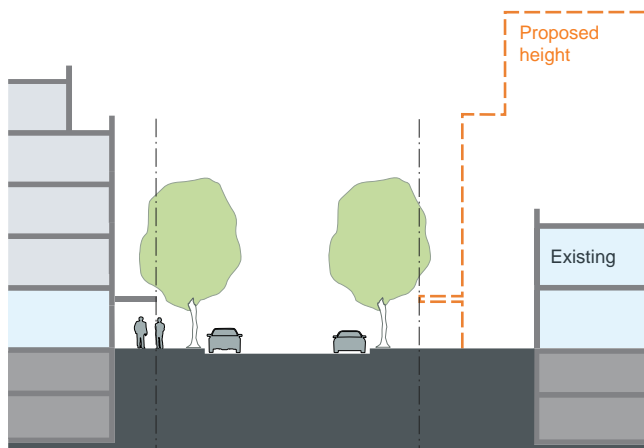

Figure 1B.3 Section showing the building envelope and scale of the proposed development in relation to the street

The range of scales

Apartment development needs to consider a range of scales during the planning and design phase.

Wider scale: The wider scale includes the urban structure, landscape setting and broader land use patterns of the wider context and identifies the development site's proximity to centres, transport and major public open spaces. It should also illustrate the future density and proposed change of the area (if known or applicable) and highlight important infrastructure such as major hospitals, schools and education facilities. Addressing this scale is important for larger precincts and redevelopment sites in particular. As a guide, a radius of 1 to 5 kilometres around the development site should be considered.

Neighbourhood scale: The neighbourhood scale outlines the urban structure including streets and open spaces. It should also include topography contours, drainage and vegetation patterns, services and future infrastructure requirements (if known), land use zones, cadastre boundaries and identification of heritage items and other local landmarks. It is appropriate to address this scale when planning for individual or small groups of apartment building sites. A radius of 400 metres to 1 kilometre should be considered.

Streetscape scale: The streetscape scale deals with the character of the street(s) that the proposed development addresses, and shows its spatial enclosure by buildings or landscape elements. It should outline surrounding building uses and heights, front setbacks, pedestrian access, awnings, vehicle driveways and public domain elements including street trees, verges and footpaths. It is appropriate that all proposals for apartment buildings address this scale.

Site scale: The site scale involves detailed consideration of the individual development site relative to neighbouring properties, buildings across the street and the public domain. It addresses surrounding and proposed deep soil zones and open spaces, existing vegetation and trees, fences, retaining walls, overshadowing impacts and privacy considerations. This scale should also highlight any other site specific factors such as orientation, slope, geology, infrastructure or access easements and stormwater management.

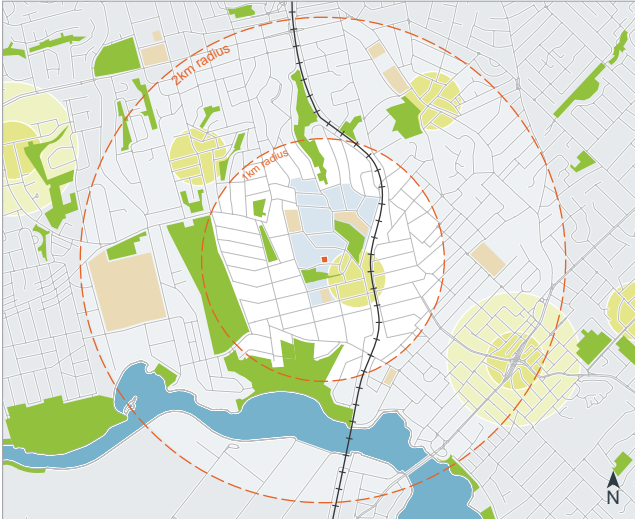

Figure 1B.4 The wider scale should analyse the urban structure and broader landscape setting and identify the site's proximity to centres, transport and major public open spaces. Proposals for larger precincts and redevelopment sites should address this scale



Figure 1B.5 The neighbourhood scale outlines the urban grid and block structure including streets and open spaces, significant topography, heritage and civic and community uses. Proposals for individual or small groups of apartment building sites should address this scale



Figure 1B.6 The streetscape scale helps understand the impact of proposed development on streetscape quality and should show heights, setbacks, driveways and existing street trees. All proposals should address this scale



Figure 1B.7 The site scale is a detailed analysis of the development's immediate context and should include the site itself, the street it addresses and surrounding properties. All proposals should address this scale

1C Precincts and individual sites



Figure 1C.1 Individual site: this development comprises two apartment buildings with a shared communal open space and mediates between low density housing and a local centre to the north

Residential apartment developments are generally developed on individual sites or within precincts.

Individual sites

An individual site is a single lot or an amalgamation of several lots that can support individual or groups of residential flat buildings.

The size, shape and orientation of individual sites directly inform the possible building types and development capacity. The generic building types in section 1A and the primary controls in Part 2 of this guide can assist in testing individual sites to determine the planning controls and supporting guidelines, such as deep soil zones, communal open spaces, privacy, solar access and natural ventilation.

Where an area is planned to change, new development needs to address the desired future character at both the neighbourhood and street scales. In established areas new development should carefully respond to neighbouring development.

Incremental change typically occurs lot by lot in established areas and can be constrained by existing development adjacent to the site. Planning and design considerations for managing this change include:

- site amalgamation requirements may be appropriate and expressed as minimum site frontages or site specific amalgamation patterns included in development control plans*
- corner sites and sites with multiple frontages can be more efficient for development yield than mid-block sites with a single frontage
- the development potential of the adjacent site is retained where zoning permits this
- avoiding left over and isolated sites that are unable to realise the planned development form and potential.

* *It is important to note that parking rates can be a significant driver for amalgamation. On sites with good public transport accessibility and limited opportunities for amalgamation, a reduction in parking rates should be considered*

Precincts

Precincts are characterised by large land parcels or a group of larger sites undergoing extensive change. These sites often need to be restructured to support a change of land use mix, building height and density.

Precinct plans typically incorporate new streets and infrastructure, through-site links and public open spaces that relate in scale, location and character to the local context. The subdivision of large land parcels into smaller ones assists in creating a finer urban grain and achieving greater diversity in building design. It can also assist with the staging of redevelopment.

Precinct plans provide a number of opportunities including:

- reconnecting parts of the city or town that have previously been isolated
- improving the public domain network and providing more public open space
- incorporating a mix of uses to support more vibrant renewal areas
- integrating heritage and important views within the site or surrounding context
- providing greater housing diversity
- providing space for new community facilities such as recreational centres, libraries and childcare centres
- leveraging efficiencies of scale to deliver more effective environmental measures such as on site energy production, integrated stormwater management and waste water recycling
- supporting greater flexibility in site layout to provide greater amenity to individual apartments and open spaces.

Precinct plans establish building envelopes and inform the controls within a local environmental plan and development control plan, against which future development applications are assessed. Indicative plans at both ground and upper levels can assist to describe the expectations of future development types within the envelope providing more certainty for local government, applicants and the community.



Figure 1C.2 Precinct: this precinct plan for the redevelopment provides a clear structure of new streets, public parklands, adaptive re-use of former tram sheds and mid block shared communal open spaces

When determining the floor space of a precinct plan, the net floor space is based on the whole site area including streets and open spaces. This will be significantly lower than the net floor space of individual parcels within the precinct plan (see also section 2D Floor space ratio).

Through the precinct plan design process and the testing of proposed building envelopes against the site constraints, alternative solutions to some of the design criteria in this guide may be appropriate.

Some design criteria may be best applied to the entire precinct area or to stages within the site, for example deep soil and communal open space may be consolidated and accessed by a number of buildings.

Other design criteria associated with the amenity of individual apartments, such as visual privacy, sunlight access and ventilation, are typically applied to each building within the precinct plan.





Part 2

Developing the controls

- 2A Primary controls
- 2B Building envelopes
- 2C Building height
- 2D Floor space ratio
- 2E Building depth
- 2F Building separation
- 2G Street setbacks
- 2H Side and rear setbacks

This part explains the application of building envelopes and primary controls including building height, floor space ratio, building depth, separation and setbacks. It provides tools to support the strategic planning process when preparing planning controls

2A Primary controls

Primary development controls are the key planning tool used to manage the scale of development so that it relates to the context and desired future character of an area and manages impacts on surrounding development.

Primary development controls include building height, floor space ratio, building depth, building separation and setbacks (refer to in sections 2C-2H). When applied together, the primary development controls create a building envelope, which forms the three dimensional volume where development should occur.

Setting and testing the controls

Primary controls should be developed taking into account sunlight and daylight access, orientation and overshadowing, natural ventilation, visual and acoustic privacy, ceiling heights, communal open space, deep soil zones, public domain interface, noise and pollution.

The controls must be carefully tested to ensure they are co-ordinated and that the desired built form outcome is achievable. They should ensure the desired density and massing can be accommodated within the building height and setback controls.

The rationale for setting primary controls needs to be explained to the community, applicants and practitioners.

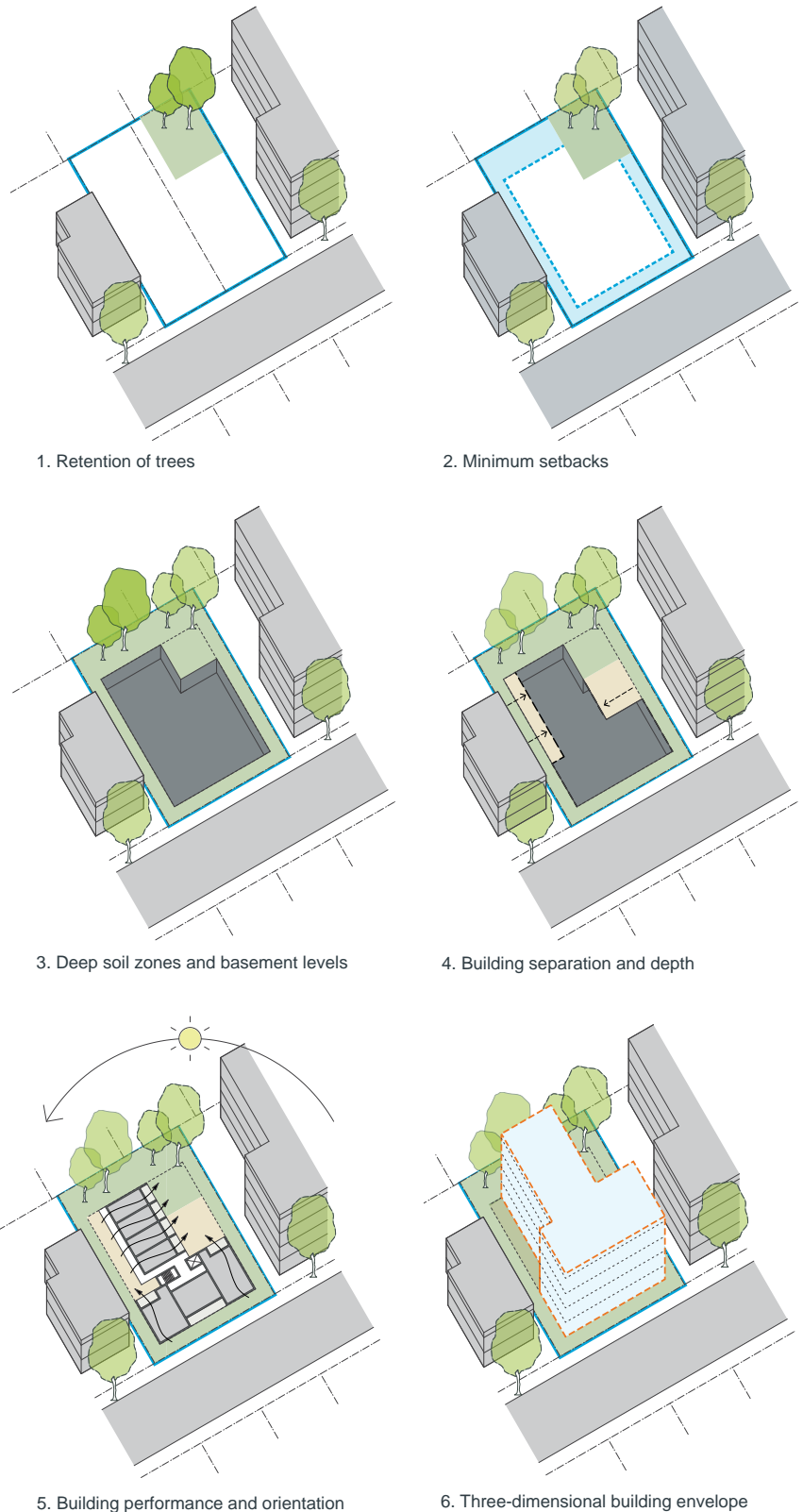

Figure 2A.1 Key considerations when testing development controls and establishing a three-dimensional building envelope

2B Building envelopes

A building envelope is a three dimensional volume that defines the outermost part of a site that the building can occupy.

Building envelopes set the appropriate scale of future development in terms of bulk and height relative to the streetscape, public and private open spaces, and block and lot sizes in a particular location. Envelopes are appropriate when determining and controlling the desired urban form in town centres, brownfield sites, precinct plan sites and special sites such as those with heritage, significant views or extreme topography.

A building envelope should be 25-30% greater than the achievable floor area (see section 2D Floor space ratio) to allow for building components that do not count as floor space but contribute to building design and articulation such as balconies, lifts, stairs and open circulation space.

Building envelopes help to:

- define the three dimensional form of buildings and wider neighbourhoods
- inform decisions about appropriate density for a site and its context
- define open spaces and landscape areas
- test the other primary controls to ensure they are coordinated and achieve the desired outcome
- demonstrate the future mass, scale and location of new development.



Figure 2B.1 Perspective of a proposed building design within the building envelope

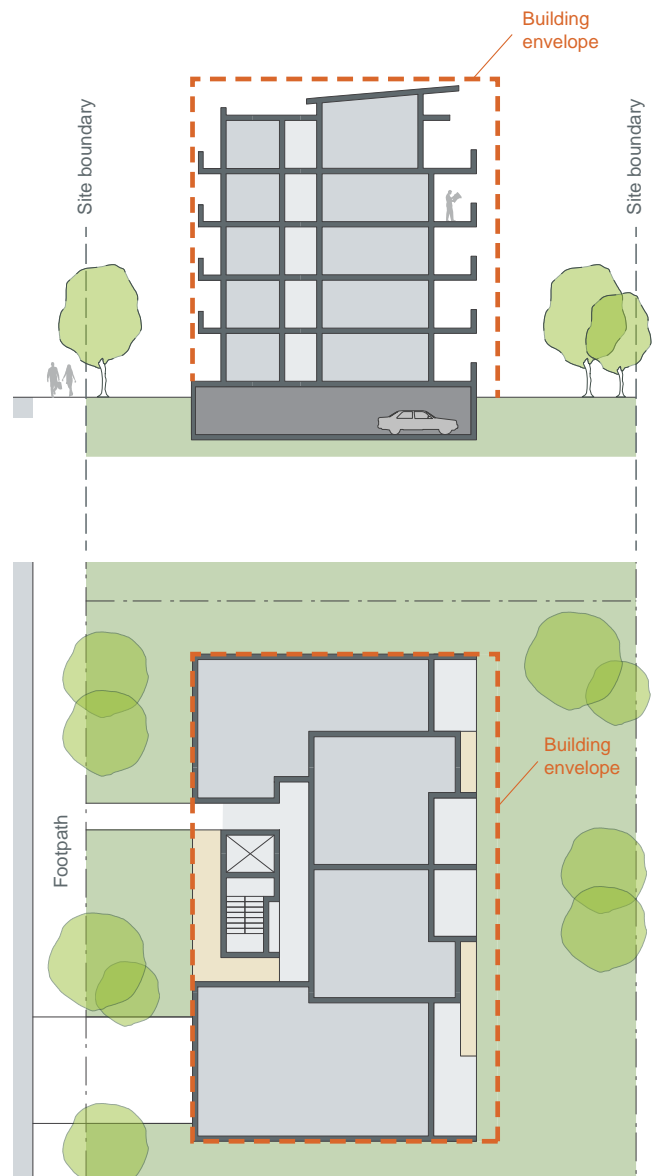

Figure 2B.2 Building envelopes define the 'container' within which a building is designed. They are a useful tool to gain an understanding of the future urban form and scale of an area. The gross floor area of the building is typically 25-30% less than that of the envelope

2C Building height

Building height helps shape the desired future character of a place relative to its setting and topography. It defines the proportion and scale of streets and public spaces and has a relationship to the physical and visual amenity of both the public and private realms.

Height controls should be informed by decisions about daylight and solar access, roof design and use, wind protection, residential amenity and in response to landform and heritage.

Aims

- building height controls ensure development responds to the desired future scale and character of the street and local area
- building height controls consider the height of existing buildings that are unlikely to change (for example a heritage item or strata subdivided building)
- adequate daylight and solar access is facilitated to apartments, common open space, adjoining properties and the public domain
- changes in landform are accommodated
- building height controls promote articulated roof design and roof top communal open spaces, where appropriate.

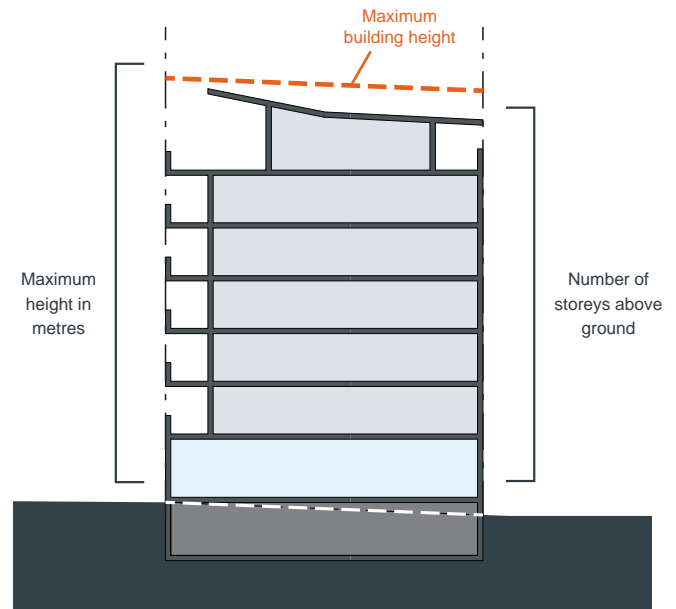

Figure 2C.1 The total height of a building informs the number of storeys possible in a development. Floor to floor heights vary depending on the use e.g. shops and offices are typically higher than residential apartments

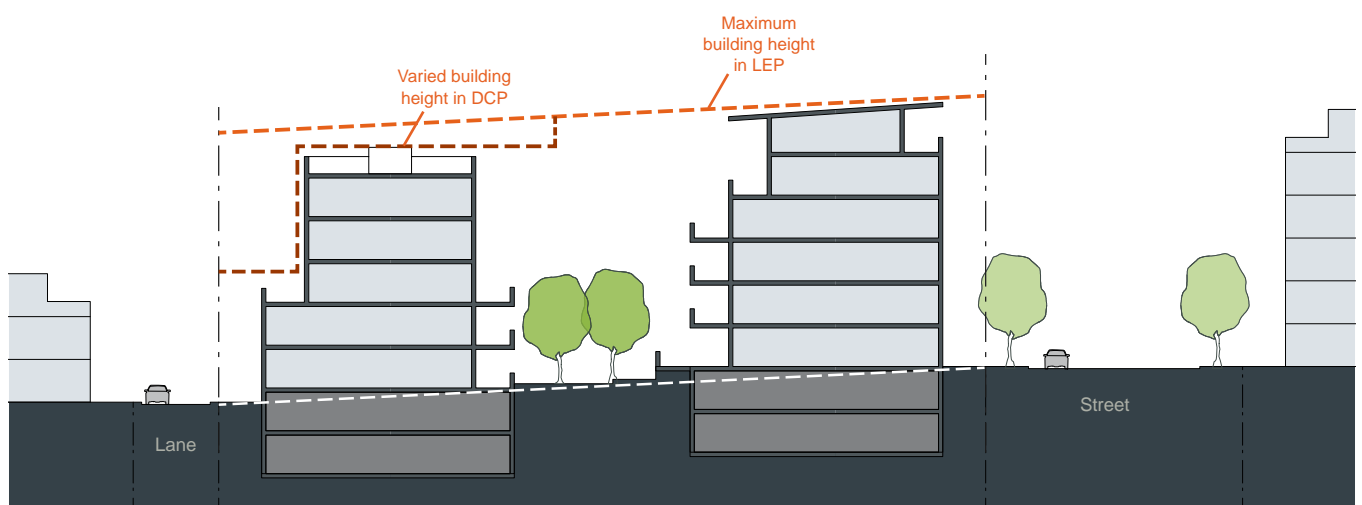

Figure 2C.2 Building height controls in a development control plan should reflect the existing or desired future character of an area. Height controls may need to step or change within a site while still being within the maximum set in the local environmental plan. This diagram shows how the height of proposed buildings responds to the lower and higher densities along each street frontage



Figure 2C.3 Building height in renewal areas should reflect the desired future character of the streetscape

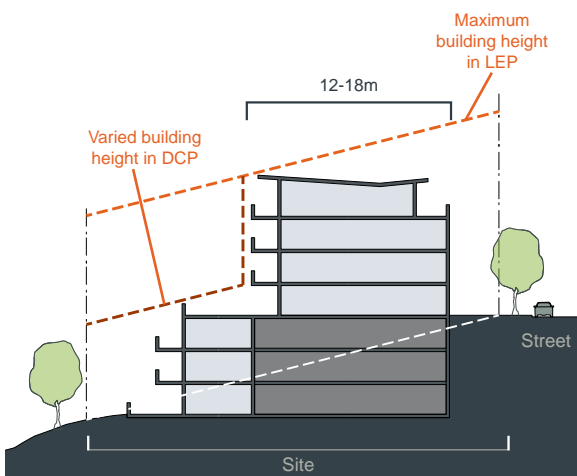

Figure 2C.4 On steep slopes across sites, a varied height control can be applied that steps down towards the lower level of the site and helps create useful residential floor plates (12-18m) addressing the street

Considerations in setting height controls

Set building heights by adding together the floor to ceiling heights for the desired number of storeys. Add 0.4m per floor for structure, services, set downs and finishes. Add 1m to the total to allow for rooftop articulation. Add 2m to the total to allow for topographic changes where required. Provide additional height in flood prone areas

Develop site-specific building envelopes and heights within a development control plan for large or complex sites such as those on steep slopes and those with changing topography. These specific heights need to be achievable within the building height set in the LEP

Ensure that building height controls respond to the desired number of storeys, the minimum floor to floor heights required for future building uses and include generous ground floor heights

Ensure the maximum building height allows for articulated roof planes and building services or that architectural roof features are enabled by the LEP

Where rooftop communal open space is desired, ensure adequate maximum height is provided and consider secondary height controls for lift/stair access and shade structures

Where a floor space ratio control is defined, test height controls against the FSR to ensure a good fit

It may be appropriate to determine heights by relating them to site-specific features such as cliff lines or heritage items. This may include:

- defining an overall height or street wall heights to key datum lines, such as eaves, parapets, cornices or spires
- aligning floor to floor heights of new development with existing built form

Consider secondary height controls to transition built form, for example:

- a street wall height to define the scale and enclosure of the street
- a step down in building height at the boundary between two height zones

The Building Code of Australia has certain requirements based on the effective height of a building. When setting height controls, consider these thresholds as it can have an impact on the feasibility of a development. Applicants should be able to design a building to the maximum height while achieving an economically viable development

2D Floor space ratio

Floor space ratio (FSR) is the relationship of the total gross floor area (GFA) of a building relative to the total site area it is built on. It indicates the intended density. FSR is a widely used method for estimating the development potential of a site.

However, it is important to note that FSR controls set the *theoretical maximum* capacity. It may not always be possible to reach the maximum allowable floor space due to other development controls or constraints specific to the site such as lot size or shape, existing landscape features, neighbouring properties or heritage considerations.

FSR is not a measure of the maximum capacity of the building envelope. The envelope provides an overall parameter for the design of the development. The allowable gross floor area should only 'fill' approximately 70% of the building envelope (see section 2B Building envelopes). In new urban areas or where an existing neighbourhood is undergoing change, building envelopes should be tested prior to setting FSR controls.

Aims

- ensure that development aligns with the optimum capacity of the site and the desired density of the local area
- provide opportunities for building articulation and creativity within a building envelope by carefully setting the allowable floor space.

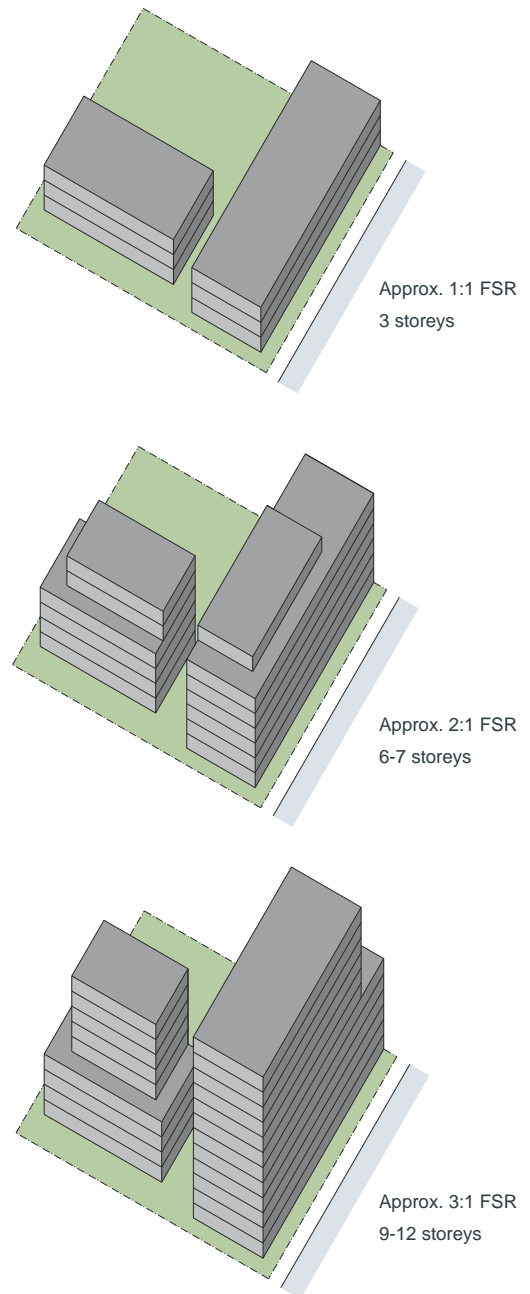

Figure 2D.1 Indicative built form massing for residential flat buildings with different floor space ratios

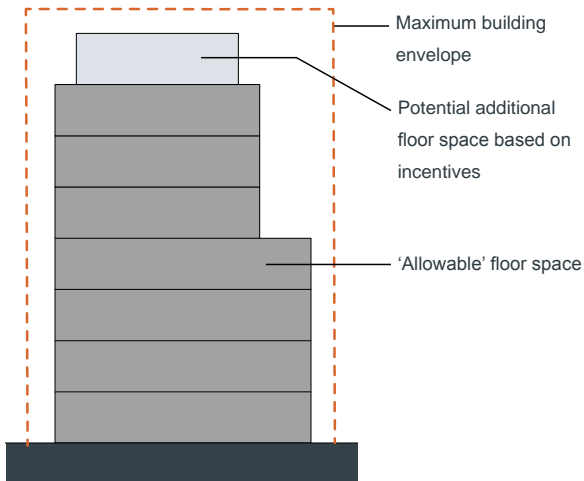

Figure 2D.2 When determining floor space ratio controls, maximum building envelopes can be used to test the FSR, including any potential incentives and bonuses

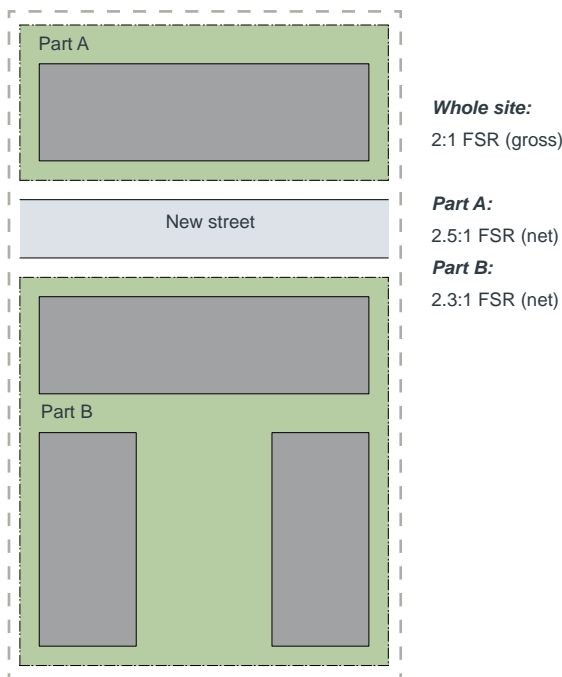

Figure 2D.3 On sites with subdivision and public domain dedication (e.g. a new street), the overall gross FSR is lower than the net FSR for each individual development parcel

Considerations in setting FSR controls

Test the desired built form outcome against the proposed FSR to ensure its is coordinated with the building envelope, height, depth, setbacks and open space requirements

The GFA should fit comfortably within the building envelope as the envelope needs to also account for building elements and service areas that are not included in the GFA definition and to allow for building articulation (see section 2B Building envelopes)

Consider how floor space is implemented across larger sites. A single floor space ratio may result in under or over development. For example, in an area with a consistent height control:

- corner, mid-block or wide shallow sites tend to have different floor space capacities
- small sites with a single building may have greater floor space capacity than larger sites with multiple buildings
- large sites with multiple buildings require greater space between buildings and may have less floor space capacity

On precinct plan sites with new streets and/or open spaces, both the gross FSR for the whole site and the net FSR for individual development parcels need to be defined. The net FSR may be significantly higher than the gross FSR

Where both residential and non-residential uses such as retail or commercial offices are permitted, develop FSR controls for each use. Commercial and retail generally fill 80-85% of their envelope. Allow for services, circulation, car park and loading requirements. Note that residential FSR tends to be lower compared with commercial or retail ratios. This is because residential buildings are typically less deep than commercial buildings to provide higher levels of internal amenity and to incorporate more non-GFA elements such as balconies

Consider opportunities to achieve public benefits such as community facilities and public domain improvements, such as new streets, through-site links and open spaces

In noisy or hostile environments, the impacts of external noise and pollution may require enclosing of balconies (e.g. wintergardens). When setting FSR controls in these situations, consider providing additional area to compensate for the enclosing of balconies

2E Building depth

Building depth is an important tool for determining the development capacity of a site. It is the overall cross section dimension of a building envelope. Building depth dimensions typically include articulation such as projecting balconies, gallery access, eaves, overhangs, sun hoods, blades and other architectural features.

Building depth influences building circulation and configuration and has a direct relationship to internal residential amenity by determining room depths, which in turn influences access to light and air. For residential development in general, narrower building depths have a greater potential to achieve optimal natural ventilation and daylight access than deeper floor plates. Depths of mixed use buildings transition from deeper commercial and retail uses at the lower levels to narrower building depths for the residential uses at upper levels.

Aims

- ensure that the bulk of the development relates to the scale of the desired future context
- ensure building depths support apartment layouts that meet the objectives, design criteria and design guidance within the Apartment Design Guide.

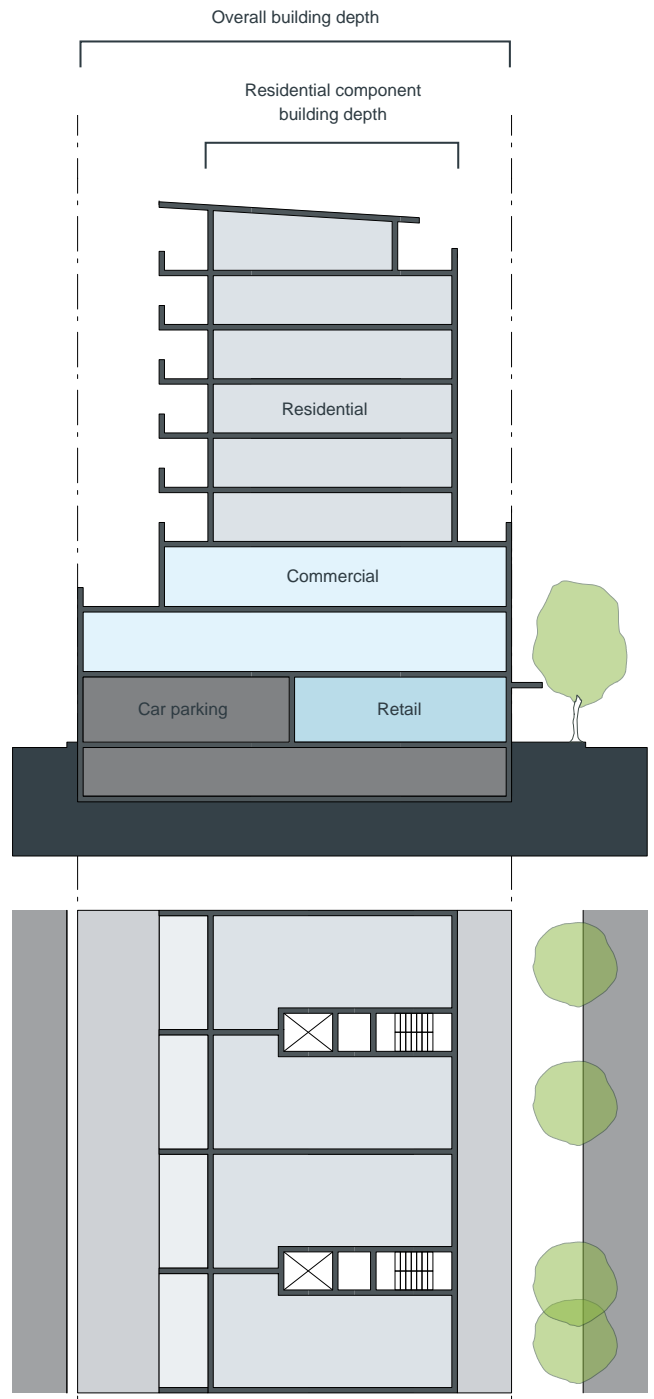

Figure 2E.1 A mixed used building showing the transition of building depth: deeper floors on lower levels dedicated to retail/commercial uses and narrower residential apartments on upper levels

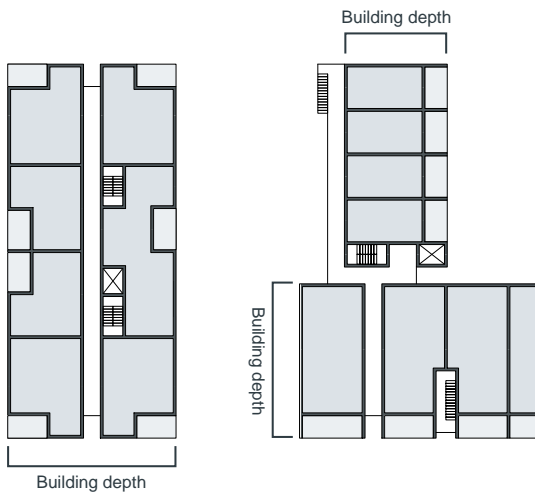

Figure 2E.2 These examples show how to measure building depth for different apartment building shapes



Figure 2E.3 Building depth dimensions should include articulation such as projecting balconies, gallery access, overhangs, blades and other architectural features

Considerations in setting building depth controls

Use a range of appropriate maximum apartment depths of 12-18m from glass line to glass line when precinct planning and testing development controls. This will ensure that apartments receive adequate daylight and natural ventilation and optimise natural cross ventilation

Test building depths against indicative floor plate and apartment layouts to ensure they can meet natural ventilation and sunlight requirements

Site constraints may require varied building depths to achieve good levels of residential amenity for residents and neighbours

Consider varying building depth relative to orientation. For example, buildings facing east-west capture sun from both aspects and may have apartments of up to 18m wide (if dual aspect), while buildings facing north-south should be narrower to reduce the number of south facing apartments that have limited or no direct sunlight access (consider relationship with section 4A Solar and daylight access)

Where greater depths are proposed, demonstrate that indicative layouts can achieve acceptable amenity with room and apartment depths. This may require significant building articulation and increased perimeter wall length

Coordinate building height and building depth:

- buildings that have smaller depths over a greater height deliver better residential amenity than those with greater depth and a lower height
- greater building depths may be possible where higher ceiling heights are provided, for example adaptive reuse of an existing building (see 4D Apartment size and layout)

For mixed use buildings, align building depth to the likely future uses. For example, transition deeper commercial or retail podium levels to a narrower residential tower above. For precinct planning, if the intended building use changes, the building depth needs to change accordingly

Set the depth control in metres. The building depth includes the internal floor plate, external walls, balconies, external circulation and articulation such as recesses and steps in plan and section

2F Building separation

Building separation is the distance measured between building envelopes or buildings. Separation between buildings contributes to the urban form of an area and the amenity within apartments and open space areas.

Amenity is improved through establishing minimum distances between apartments within the site, between apartments and non-residential uses and with boundaries to neighbours. Building separation ensures communal and private open spaces can have useable space with landscaping, deep soil and adequate sunlight and privacy. Within apartments, building separation assists with visual and acoustic privacy, outlook, natural ventilation and daylight access.

Building separation controls should be set in conjunction with height controls and controls for private/communal open space and visual and acoustic privacy.

Aims

- ensure that new development is scaled to support the desired future character with appropriate massing and spaces between buildings
- assist in providing residential amenity including visual and acoustic privacy, natural ventilation, sunlight and daylight access and outlook
- provide suitable areas for communal open spaces, deep soil zones and landscaping.

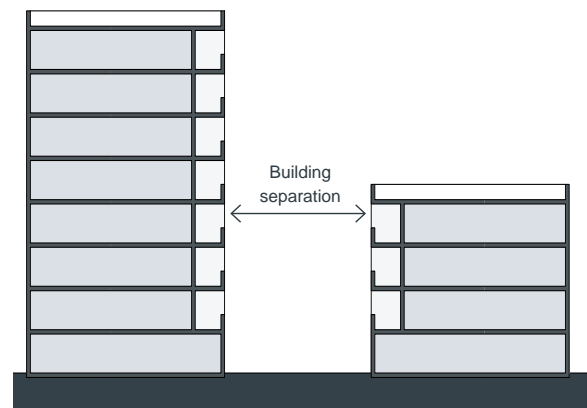

Figure 2F.1 Building separation is measured from the outer face of building envelopes which includes balconies

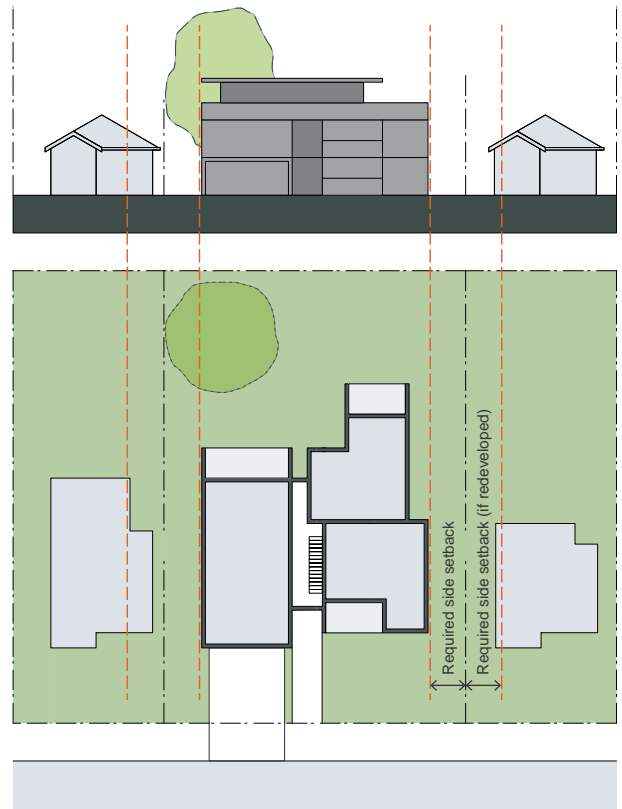

Figure 2F.2 In areas undergoing transition from low density to higher densities, minimum building separation distances may not be achieved until the area completes its transition



Figure 2F.3 Building separation supports residential amenity and helps to provide suitable communal open space areas

Table 1 Minimum building separation increases proportionally to the building height

Building height	Separation distance
9 storeys and above	12-24m
Up to 8 storeys	9-18m
Up to 4 storeys	6-12m

How to measure building separation

Gallery access circulation areas should be treated as habitable space, with separation measured from the exterior edge of the circulation space.

When measuring the building separation between commercial and residential uses, consider office windows and balconies as habitable space and service and plant areas as non-habitable.

Where applying separation to buildings on adjoining sites, apply half the minimum separation distance measured to the boundary. This distributes the building separation equally between sites (consider relationship with section 3F Visual privacy).

Considerations in setting building separation controls

Design and test building separation controls in plan and section

Test building separation controls for sunlight and daylight access to buildings and open spaces

Minimum separation distances for buildings are:

Up to four storeys (approximately 12m):

- 12m between habitable rooms/balconies
- 9m between habitable and non-habitable rooms
- 6m between non-habitable rooms

Five to eight storeys (approximately 25m):

- 18m between habitable rooms/balconies
- 12m between habitable and non-habitable rooms
- 9m between non-habitable rooms

Nine storeys and above (over 25m):

- 24m between habitable rooms/balconies
- 18m between habitable and non-habitable rooms
- 12m between non-habitable rooms

Building separation may need to be increased to achieve adequate sunlight access and enough open space on the site, for example on slopes

Increase building separation proportionally to the building height to achieve amenity and privacy for building occupants and a desirable urban form

At the boundary between a change in zone from apartment buildings to a lower density area, increase the building setback from the boundary by 3m

No building separation is necessary where building types incorporate blank party walls. Typically this occurs along a main street or at podium levels within centres

Required setbacks may be greater than required building separations to achieve better amenity outcomes

2G Street setbacks

Street setbacks establish the alignment of buildings along the street frontage, spatially defining the width of the street. Combined with building height and road reservation, street setbacks define the proportion and scale of the street and contribute to the character of the public domain.

In a centre, the street setback or building line may be set at the property boundary defining the street corridor with a continuous built edge. In a suburban context, the street setback may accommodate front gardens, contributing to the landscape setting of buildings and the street. Street setbacks provide space for building entries, ground floor apartment courtyards and entries, landscape areas and deep soil zones.

Aims

- establish the desired spatial proportions of the street and define the street edge
- provide space that can contribute to the landscape character of the street where desired
- create a threshold by providing a clear transition between the public and private realms
- assist in achieving visual privacy to apartments from the street
- create good quality entries to lobbies, foyers or individual dwellings
- promote passive surveillance and outlook to the street.



Figure 2G.1 For mixed use buildings with retail uses at the ground floor a zero setback is appropriate



Figure 2G.2 This example provides a landscaped setback which contributes to the residential character of the street

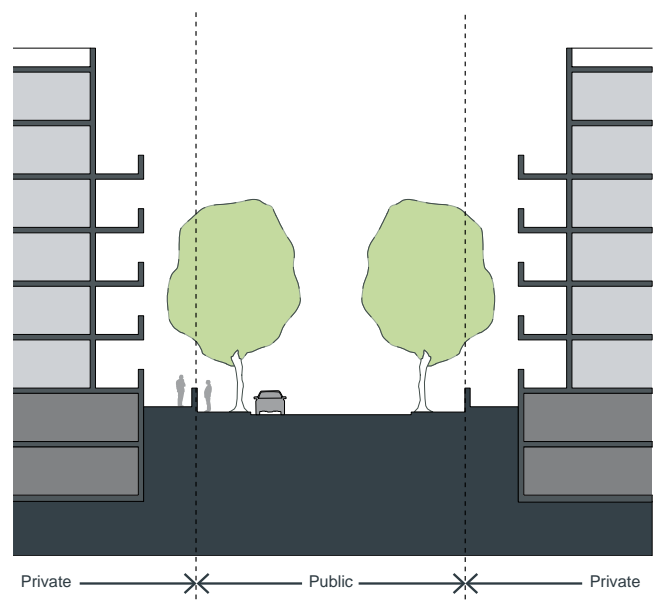
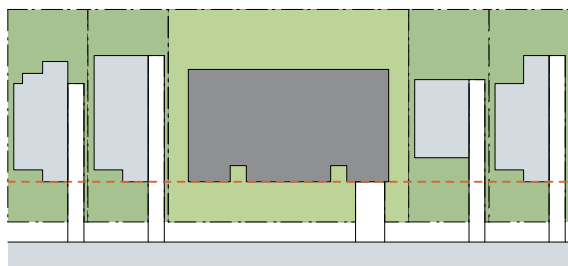
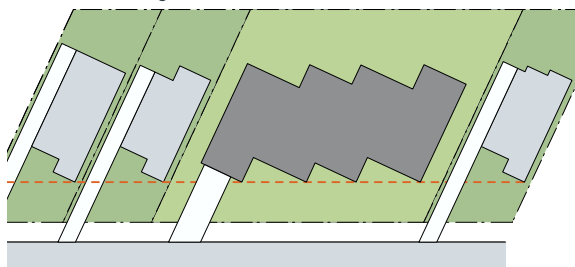

Figure 2G.3 Streetscapes are defined by a combination of public elements (carriageways, kerbs, verges and footpaths) and private elements (street setbacks, fences and building facades)

1. Predominant setback



2. Variation for angled subdivision



3. Setback range

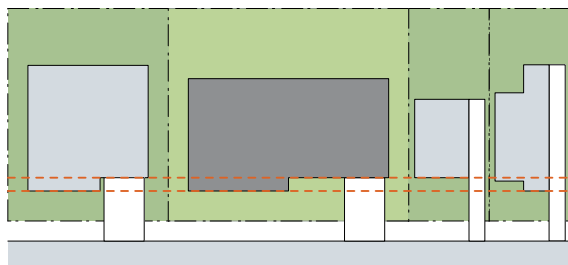

4. Building line

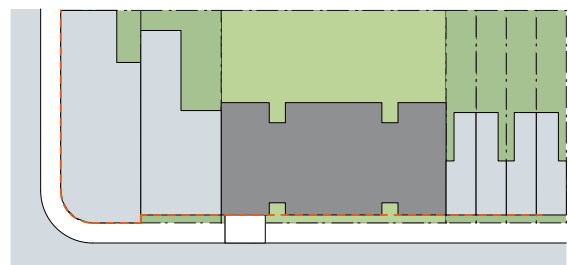

Figure 2G.4 Street setbacks should be consistent with existing setback patterns in the street or setbacks that achieve the desired future character of the area

Considerations in setting street setback controls

Determine street setback controls relative to the desired streetscape and building forms, for example:

- define a future streetscape with the front building line
- match existing development
- step back from special buildings
- retain significant trees
- in centres the street setback may need to be consistent to reinforce the street edge
- consider articulation zones accommodating balconies, landscaping etc. within the street setback
- use a setback range where the desired character is for variation within overall consistency, or where subdivision is at an angle to the street
- manage corner sites and secondary road frontages

Align street setbacks with building use. For example in mixed use buildings a zero street setback is appropriate

Consider nominating a maximum percentage of development that may be built to the front build-to line, where one is set, to ensure modulated frontages along the length of buildings

Identify the quality, type and use of open spaces and landscaped areas facing the street so setbacks can accommodate landscaping and private open space

In conjunction with height controls, consider secondary upper level setbacks to:

- reinforce the desired scale of buildings at the street frontage
- minimise overshadowing of the street and other buildings

To improve passive surveillance, promote setbacks which ensure a person on a balcony or at a window can easily see the street

Consider increased setbacks where street or footpath widening is desired

2H Side and rear setbacks

Side and rear setbacks govern the distance of a building from the side and rear site boundaries and are related to the height of the building. They are important tools for achieving amenity for new development and buildings on adjacent sites.

Setbacks vary according to the building's context and type. Larger setbacks can be expected in suburban contexts in comparison to higher density urban settings. Setbacks provide transition between different land uses and building typologies. Side and rear setbacks can also be used to create useable land for common open space, tree planting and landscaping.

Aims

- provide access to light, air and outlook for neighbouring properties and future buildings
- provide for adequate privacy between neighbouring apartments
- retain or create a rhythm or pattern of spaces between buildings that define and add character to the streetscape
- achieve setbacks that maximise deep soil areas, retain existing landscaping and support mature vegetation consolidated across sites
- manage a transition between sites or areas with different development controls such as height and land use.



Figure 2H.1 Side setbacks can contribute to the character of the street, for example by allowing views to existing vegetation at the rear of buildings

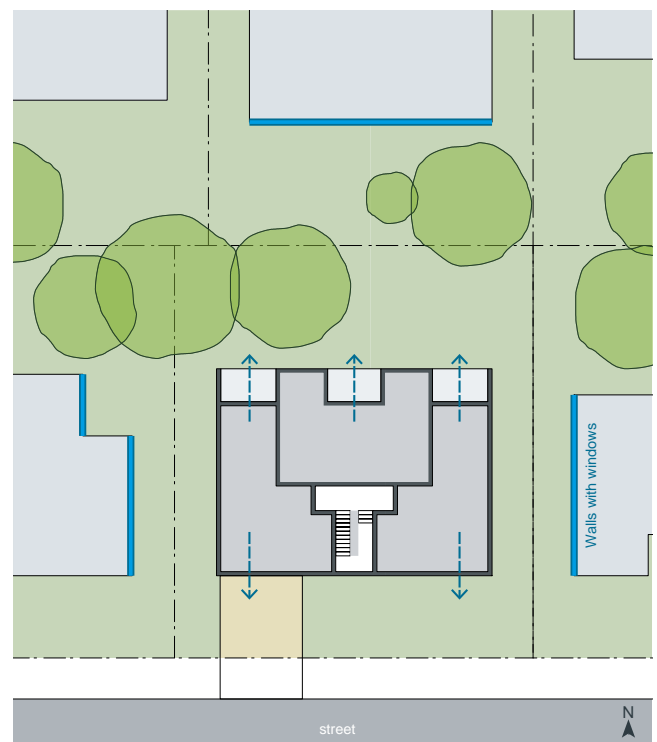

Figure 2H.2 On infill sites follow the existing open space patterns, limit side setbacks and locate habitable rooms to face the street and rear boundary to optimise amenity and privacy for all

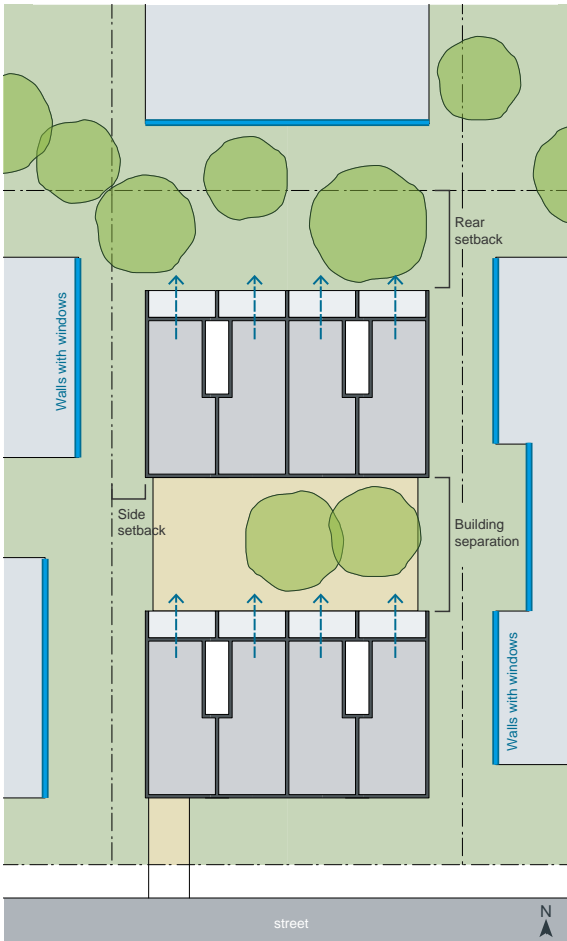

Figure 2H.3 On narrow infill sites select a building type that orientates habitable rooms to the street and rear, minimising required side setbacks

Considerations in setting side and rear setback controls

Test side and rear setbacks with height controls for overshadowing of the site, adjoining properties and open spaces

Test side and rear setbacks with the requirements for:

- building separation and visual privacy
- communal and private open space
- deep soil zone requirements

Consider zero side setbacks where the desired character is for a continuous street wall, such as in dense urban areas, main streets or for podiums within centres

On sloping sites, consider increasing side and rear setbacks where new development is uphill to minimise overshadowing and assist with visual privacy



Figure 2H.4 Side and rear setbacks vary according to the building context and type. In urban areas, setbacks are often guided by minimum building separation requirements

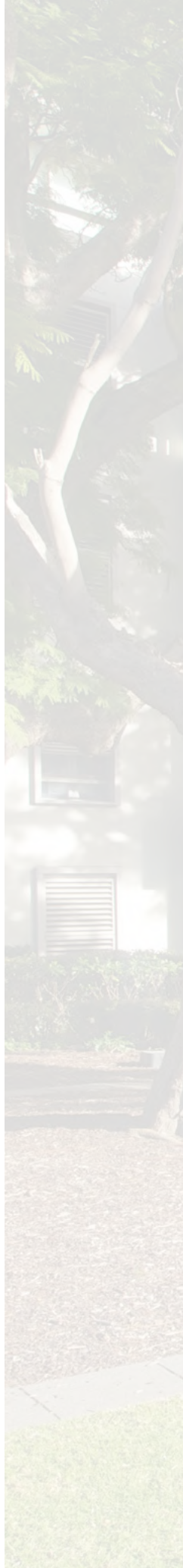



Part 3

Siting the development

- 3A Site analysis
- 3B Orientation
- 3C Public domain interface
- 3D Communal and public open space
- 3E Deep soil zones
- 3F Visual privacy
- 3G Pedestrian access and entries
- 3H Vehicle access
- 3J Bicycle and car parking

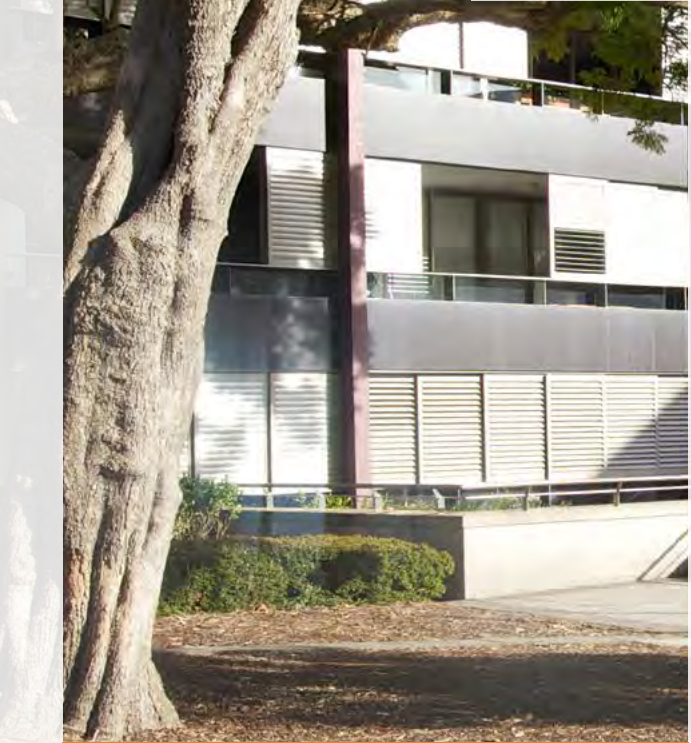

This part provides guidance on the design and configuration of apartment development at a site scale. Objectives, design criteria and design guidance outline how to relate to the immediate context, consider the interface to neighbours and the public domain, achieve quality open spaces and maximise residential amenity. It is to be used during the design process and in the preparation and assessment of development applications

3A Site analysis

Site analysis is an important part of the design process and should be undertaken at the outset of a project to inform the design principles. Development proposals need to illustrate that design decisions are based on careful analysis of the site conditions and relationship to the surrounding context.

By describing the physical elements of the locality and the conditions impacting on the site, opportunities and constraints for future apartment development can be identified and addressed in the design. It may be beneficial to undertake a site analysis in collaboration with technical consultants, depending on the nature of the site and scale of development.

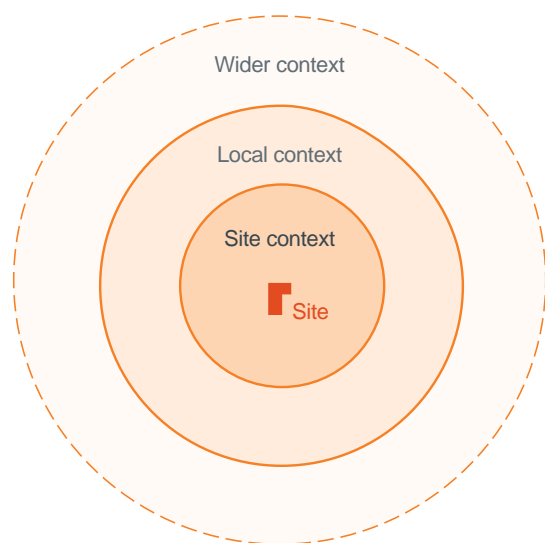

The key elements of a site analysis include:

1. Site location plan

A plan showing the wider context that identifies the site in relation to retail and commercial areas, community facilities and transport.

2. Aerial photograph

A colour aerial photograph of the development site and surrounding context.

3. Local context plan

Plan drawing(s) of the existing features of the local context including relevant sections and elevations should also be provided, especially for sloping sites. Information may include but is not limited to:

- land use, height and typology of adjacent and opposite buildings in the street
- views to and from the site
- circulation patterns and access for pedestrians, vehicles and servicing
- location of heritage items and areas of environmental significance
- patterns of buildings, open spaces and vegetation
- significant noise sources on and near the site, particularly roads, rail, aircraft and industrial noise
- building envelopes and setbacks for future development
- a written statement of key issues.

4. Site context and survey plan

Plan and section drawings of existing site features including properties that are adjoining and on the other side of the street, together with appropriate written material. Information may include but is not limited to:

- site dimensions, site areas and north point
- topography showing spot levels and contours at 0.5m intervals, any unique natural features such as rock outcrops or watercourses and clearly identify adjoining streets and land adjoining the site
- location of major trees on site and adjacent properties including identification of canopy size and species
- location and use of any existing buildings or built features on the site
- location and important characteristics of adjacent public, communal and private open spaces
- location and height of existing windows, balconies, walls and fences on adjacent properties, as well as parapet and ridge lines
- pedestrian and vehicular access points
- location of utility services including electricity poles, substation kiosks, stormwater drainage, natural drainage, kerb crossings and easements.

3A Site analysis

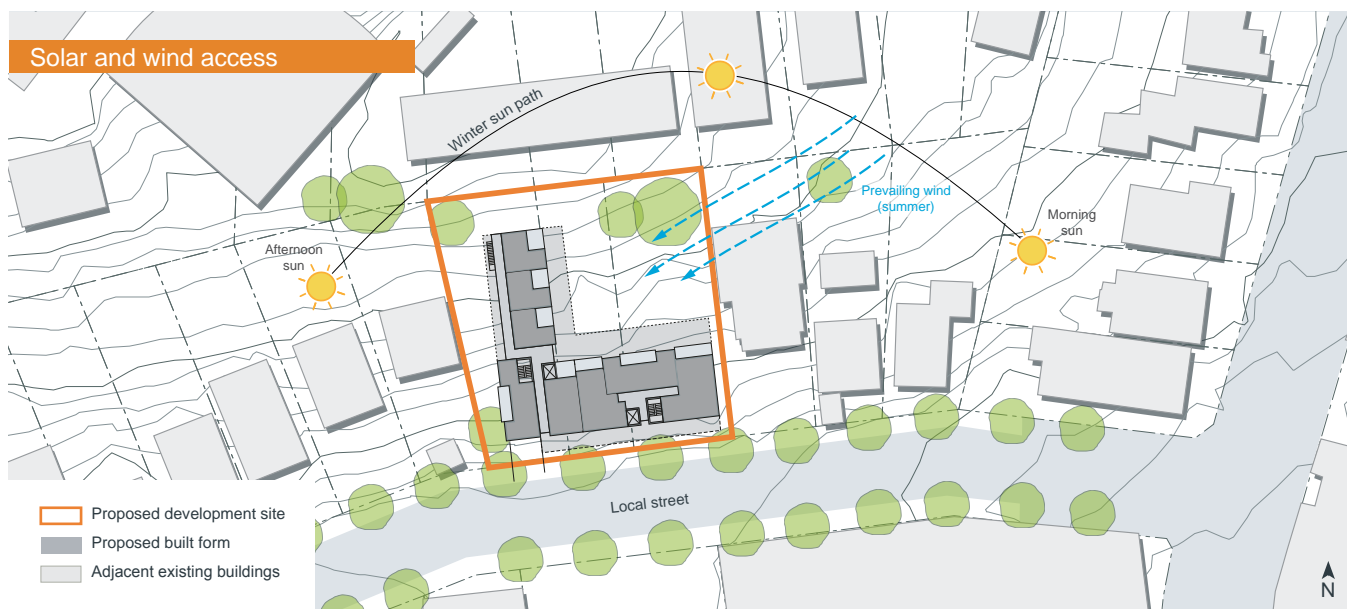

Figure 3A.4 Analysis of solar and wind access

5. Streetscape elevations and sections

Photographs and drawings of nearby existing buildings help explain the existing scale of the area, the spacing of development and the local architectural character. Information may include but is not limited to:

- streetscape showing both sides of any street that the development fronts including the patterns of building frontages, street and side setbacks
- adjacent buildings showing overall height (in metres and storeys) and important parapet and datum lines, awnings, colonnades and other building elements
- planned heights or building envelopes
- a written statement of key issues.

6. Analysis

These plans and sections synthesise and interpret the context, streetscape and site documentation into opportunities and constraints that generate design parameters. Analysis information may include:

- overshadowing of the site and adjoining properties by neighbouring structures. The winter sun path should be shown from 9 am to 3 pm on 21 June
- direction of prevailing wind
- geotechnical characteristics of the site including topography, and how this relates to the proposed development
- public domain interface and street setback
- relationship to and interface with adjacent properties, including side and rear setbacks
- orientation including solar access and ventilation
- building footprint location
- retained trees and tree protection zones
- proposed trees and deep soil zones
- communal open space location
- building entries
- car park footprint and depth.

A written statement explaining how the design of the proposed development has responded to the site analysis must accompany the development application. Where relevant, this should include technical advice from landscape architects, contamination specialists, geotechnical engineers and arborists.

See Appendix 1 Site Analysis Checklist, Appendix 2 Pre-development application design proposal check sheet and Appendix 3 Development Application Recommended Documentation Checklist.

Objective 3A-1

Site analysis illustrates that design decisions have been based on opportunities and constraints of the site conditions and their relationship to the surrounding context

Design guidance

Each element in the Site Analysis Checklist should be addressed (see Appendix 1)

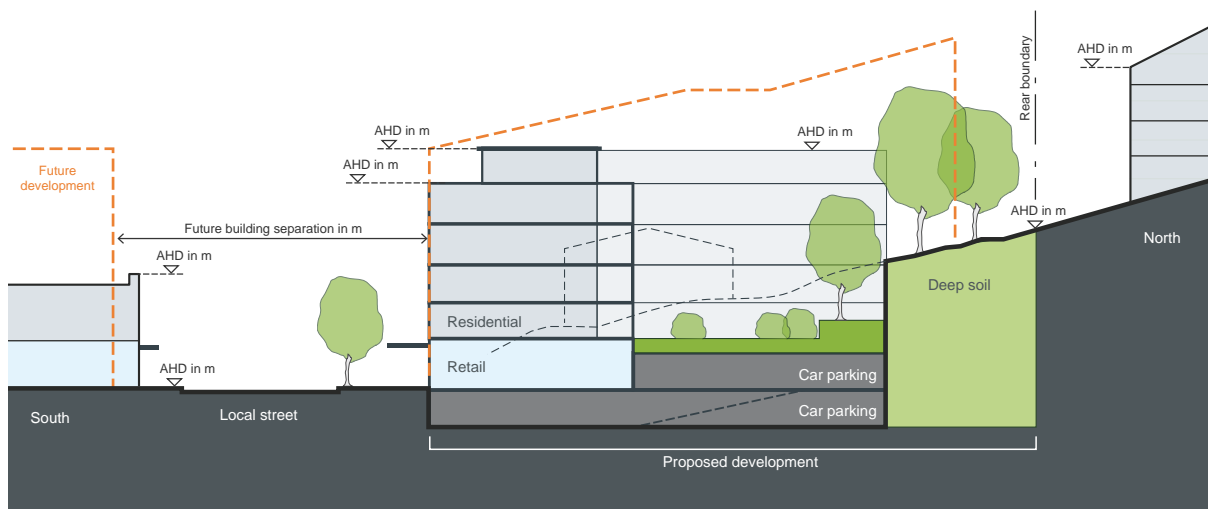

Figure 3A.5 Cross section

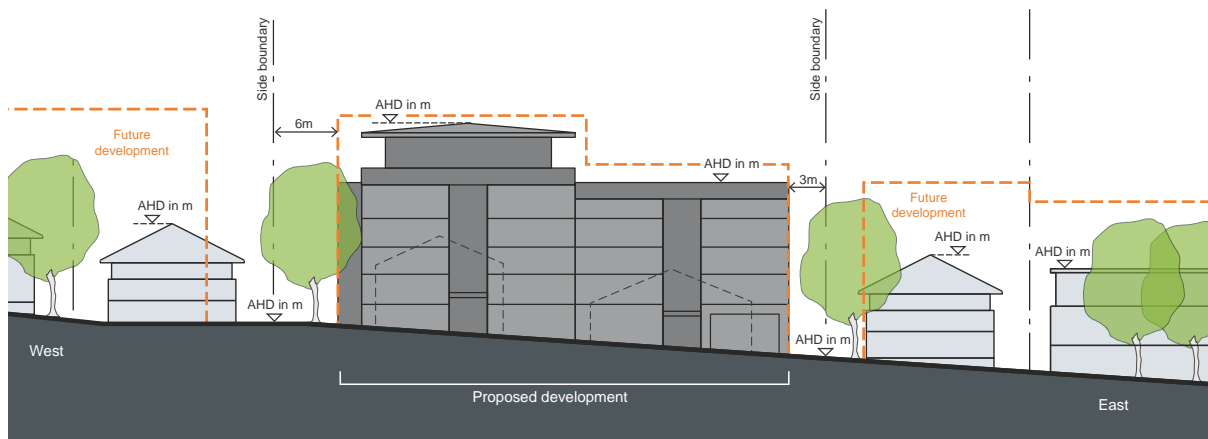

Figure 3A.6 Streetscape elevation

3B Orientation

Orientation is the position of a building and its internal spaces in relation to its site, the street, the subdivision and neighbouring buildings. Building orientation influences the urban form of the street and building address. Building orientation directly affects residential amenity including solar access and influences other matters including visual and acoustic privacy to both the development and neighbouring sites.

Designing the site layout to maximise northern orientation is an important consideration, but it must be balanced with:

- responding to desired streetscape character
- promoting amenity for both the proposed development and neighbouring properties
- providing for the enjoyment of significant views
- retaining trees and locating open spaces
- responding to the topography and contextual constraints such as overshadowing and noise.



Figure 3B.1 Proposed buildings are sited to clearly address the street while maximising solar access to apartments

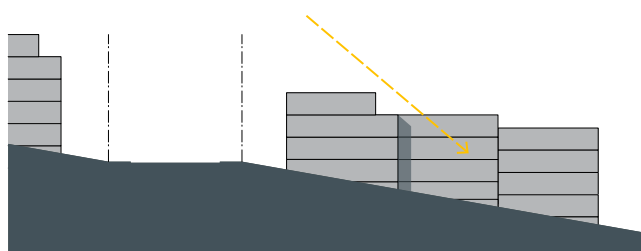

South facing slope

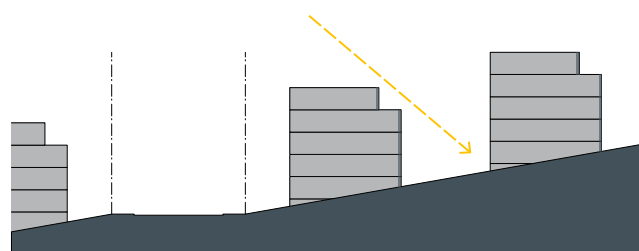
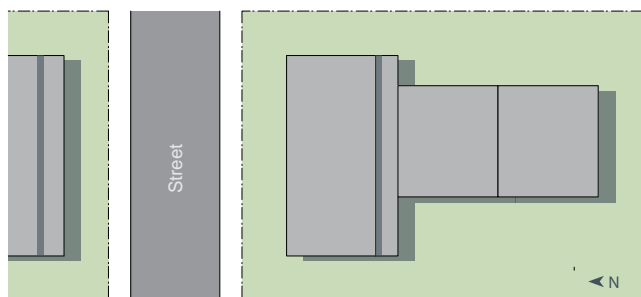

North facing slope

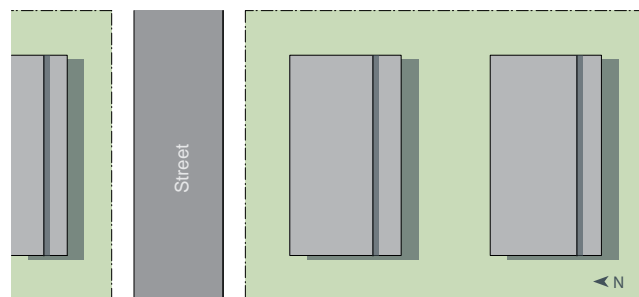

Figure 3B.2 Building orientation and height influences solar access to apartments and common open spaces. On south facing slopes, orient the rear wing of the building(s) east to west to maximise solar access, on north facing slopes, step building(s) with the slope

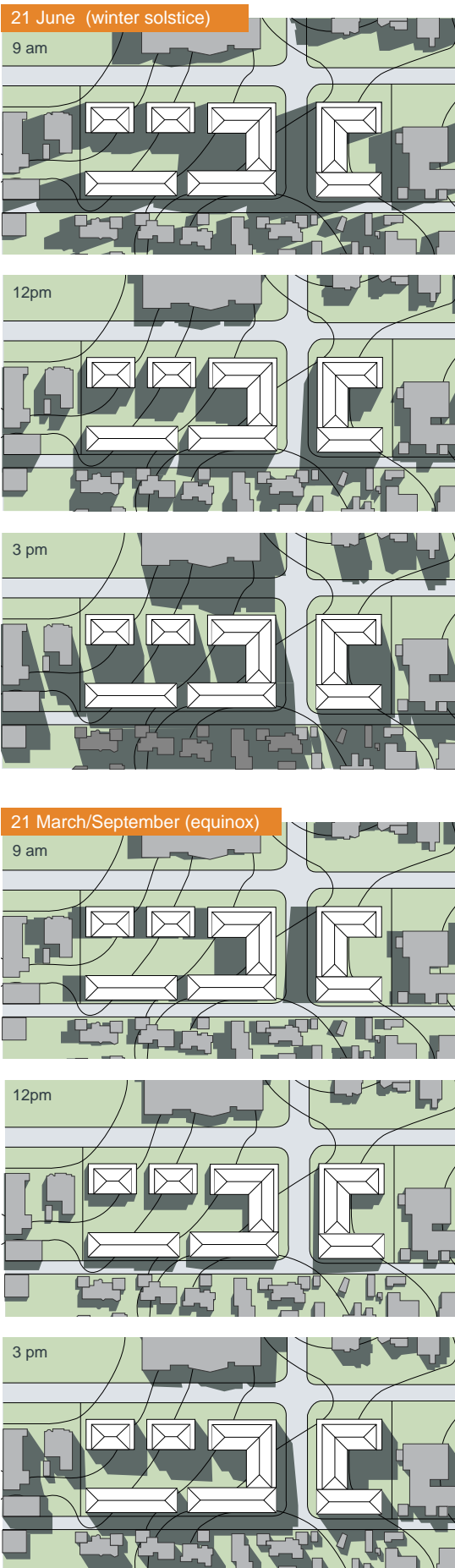

Figure 3B.3 Shadow diagrams demonstrate the impact of overshadowing within and beyond the site

Objective 3B-1

Building types and layouts respond to the streetscape and site while optimising solar access within the development

Design guidance

Buildings along the street frontage define the street, by facing it and incorporating direct access from the street (see figure 3B.1)

Where the street frontage is to the east or west, rear buildings should be orientated to the north

Where the street frontage is to the north or south, overshadowing to the south should be minimised and buildings behind the street frontage should be orientated to the east and west (see figure 3B.2)

Objective 3B-2

Overshadowing of neighbouring properties is minimised during mid winter

Design guidance

Living areas, private open space and communal open space should receive solar access in accordance with sections 3D Communal and public open space and 4A Solar and daylight access

Solar access to living rooms, balconies and private open spaces of neighbours should be considered

Where an adjoining property does not currently receive the required hours of solar access, the proposed building ensures solar access to neighbouring properties is not reduced by more than 20%

If the proposal will significantly reduce the solar access of neighbours, building separation should be increased beyond minimums contained in section 3F Visual privacy

Overshadowing should be minimised to the south or down hill by increased upper level setbacks

It is optimal to orientate buildings at 90 degrees to the boundary with neighbouring properties to minimise overshadowing and privacy impacts, particularly where minimum setbacks are used and where buildings are higher than the adjoining development

A minimum of 4 hours of solar access should be retained to solar collectors on neighbouring buildings

3C Public domain interface

The public domain interface is the transition area between the apartment building, its private or communal space at the street edge and the public domain.

The interface of the development contributes to the quality and character of the street. Subtle variations through planting and fencing can create an attractive and active public domain with a pedestrian scale. Long, high blank walls or fences can detract from the appearance of the public domain and impact on the safety of pedestrians and residents. Direct access from the street to ground floor apartments and windows overlooking the street can improve safety and social interaction.

Key components to consider when designing the interface include entries, private terraces or balconies, fences and walls, changes in level, services locations and planting. The design of these elements can influence the real or perceived safety and security of residents, opportunities for social interaction and the identity of the development when viewed from the public domain.

See also sections 3G Pedestrian access and entries, 3H Vehicle access and 4S Mixed use.

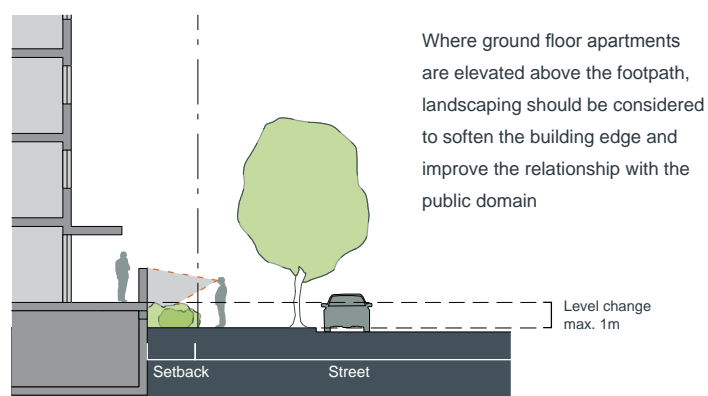
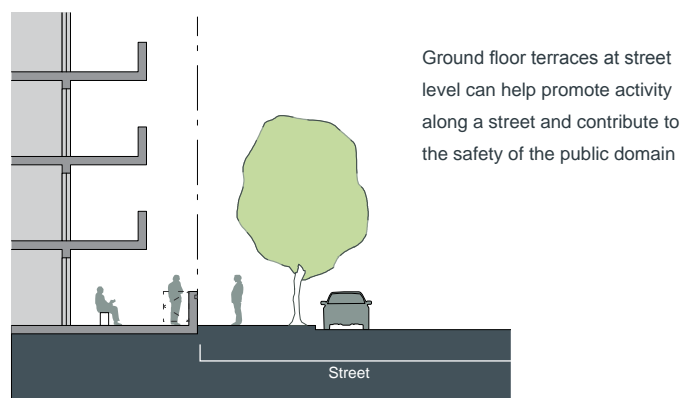
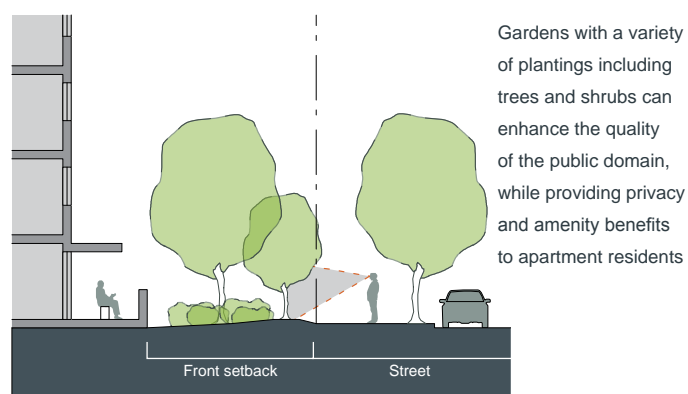
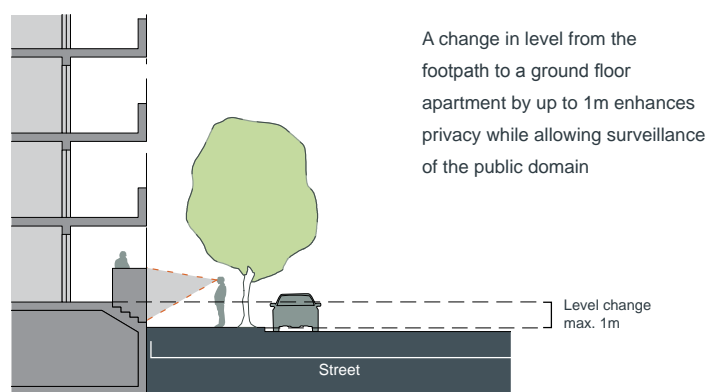

Figure 3C.1 Diagrams illustrating various public domain interface scenarios



Objective 3C-1

Transition between private and public domain is achieved without compromising safety and security

Design guidance

Terraces, balconies and courtyard apartments should have direct street entry, where appropriate

Changes in level between private terraces, front gardens and dwelling entries above the street level provide surveillance and improve visual privacy for ground level dwellings (see figure 3C.1)

Upper level balconies and windows should overlook the public domain

Front fences and walls along street frontages should use visually permeable materials and treatments. The height of solid fences or walls should be limited to 1m

Length of solid walls should be limited along street frontages

Opportunities should be provided for casual interaction between residents and the public domain. Design solutions may include seating at building entries, near letter boxes and in private courtyards adjacent to streets

In developments with multiple buildings and/or entries, pedestrian entries and spaces associated with individual buildings/entries should be differentiated to improve legibility for residents, using a number of the following design solutions:

- architectural detailing
- changes in materials
- plant species
- colours

Opportunities for people to be concealed should be minimised

3C Public domain interface

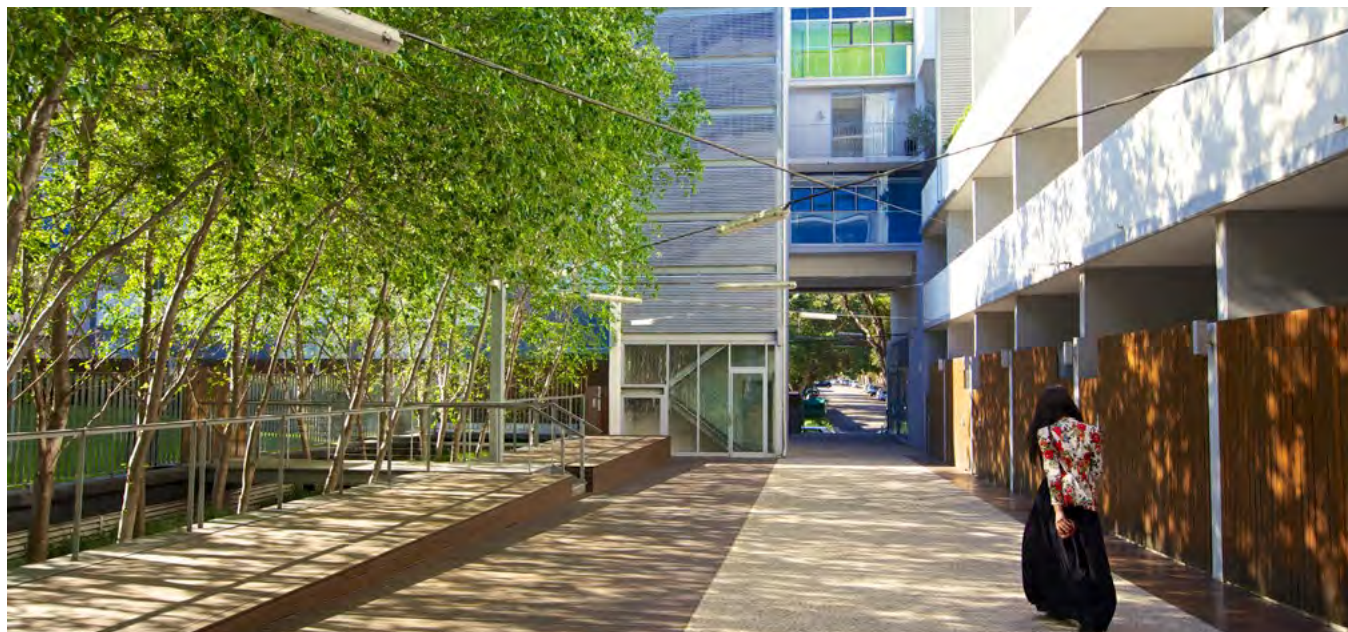

Figure 3C.2 This courtyard design locates tree planting along the pedestrian pathway, allowing for natural ventilation and daylight access to the adjacent underground car parking below, and visual screening of the car park



Figure 3C.3 Planting can be used to soften the edges of raised terraces to the street



Figure 3C.4 Front fences along public street frontages should use visually permeable materials and treatments such as timber slats



Figure 3C.5 Setbacks can be used to retain existing trees which increases the quality of the development and the public domain



Figure 3C.6 This development makes use of landscaping, pathways and building entries to clearly identify the transition between public and private space

Objective 3C-2

Amenity of the public domain is retained and enhanced

Design guidance

Planting softens the edges of any raised terraces to the street, for example above sub-basement car parking

Mail boxes should be located in lobbies, perpendicular to the street alignment or integrated into front fences where individual street entries are provided

The visual prominence of underground car park vents should be minimised and located at a low level where possible

Substations, pump rooms, garbage storage areas and other service requirements should be located in basement car parks or out of view

Ramping for accessibility should be minimised by building entry location and setting ground floor levels in relation to footpath levels

Durable, graffiti resistant and easily cleanable materials should be used

Where development adjoins public parks, open space or bushland, the design positively addresses this interface and uses a number of the following design solutions:

- street access, pedestrian paths and building entries which are clearly defined
- paths, low fences and planting that clearly delineate between communal/private open space and the adjoining public open space
- minimal use of blank walls, fences and ground level parking

On sloping sites protrusion of car parking above ground level should be minimised by using split levels to step underground car parking

3D Communal and public open space

Communal open space is an important environmental resource that provides outdoor recreation opportunities for residents, connection to the natural environment and valuable 'breathing space' between apartment buildings. It also contributes to the appeal of a development and the wellbeing of residents. Some communal open space is accessible and usable by the general public.

The size, location and design of communal or public open space will vary depending on the site context and the scale of development. The function of open space is to provide amenity in the form of:

- landscape character and design
- opportunities for group and individual recreation and activities
- opportunities for social interaction
- environmental and water cycle management
- opportunities to modify microclimate
- amenity and outlook for residents.

The useable part of the communal open space area may be supplemented by:

- additional landscape area, circulation space and areas for passive use and outlook
- public land used for open space and vested in or under the control of a public authority.

High quality open space is particularly important and beneficial in higher density developments (for private open space requirements see section 4E Private open space and balconies).

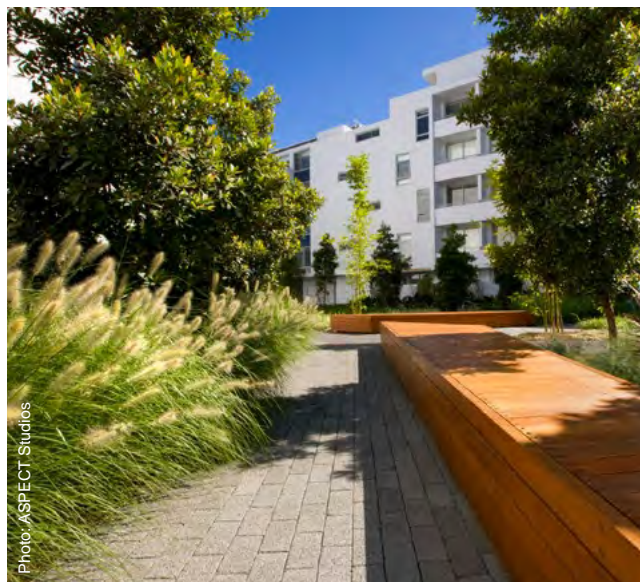

Figure 3D.1 Quality landscape design of communal spaces and pathways is particularly important for high density developments



Figure 3D.2 Communal open spaces can be located on the podium or roofs and should offer gathering areas to provide opportunity for social interaction amongst residents

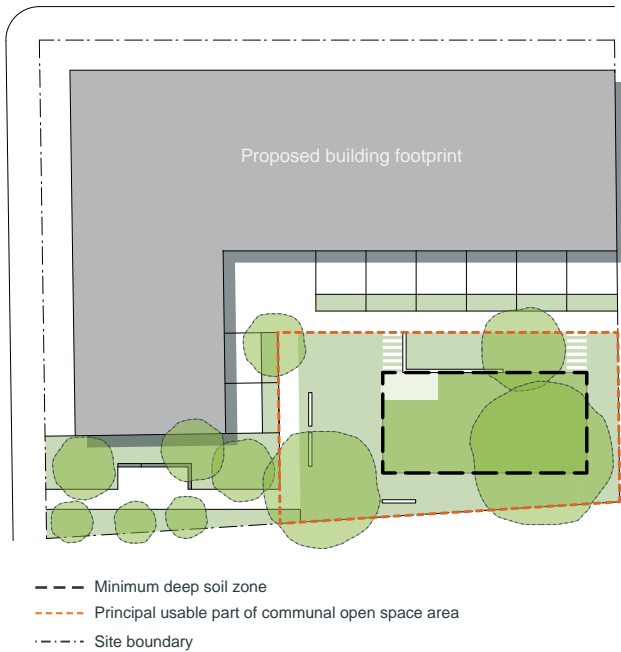

Figure 3D.3 The principal usable part of communal open spaces should be consolidated



Figure 3D.4 Recreation areas such as the communal garden setting above allow residents to relax and connect to the natural environment

Objective 3D-1

An adequate area of communal open space is provided to enhance residential amenity and to provide opportunities for landscaping

Design criteria

1. Communal open space has a minimum area equal to 25% of the site (see figure 3D.3)
2. Developments achieve a minimum of 50% direct sunlight to the principal usable part of the communal open space for a minimum of 2 hours between 9 am and 3 pm on 21 June (mid winter)

Design guidance

Communal open space should be consolidated into a well designed, easily identified and usable area

Communal open space should have a minimum dimension of 3m, and larger developments should consider greater dimensions

Communal open space should be co-located with deep soil areas

Direct, equitable access should be provided to communal open space areas from common circulation areas, entries and lobbies

Where communal open space cannot be provided at ground level, it should be provided on a podium or roof

Where developments are unable to achieve the design criteria, such as on small lots, sites within business zones, or in a dense urban area, they should:

- provide communal spaces elsewhere such as a landscaped roof top terrace or a common room
- provide larger balconies or increased private open space for apartments
- demonstrate good proximity to public open space and facilities and/or provide contributions to public open space

3D Communal and public open space



Figure 3D.5 Well designed public and communal open spaces invite informal recreation and outdoor activities



Figure 3D.6 Play facilities and spaces should be safe, overlooked by development and provide shade areas for children to play



Figure 3D.7 The location and design of open space responds to microclimate and site conditions

Photo: McGregor Coxall



Figure 3D.8 The public open space should be well connected with public streets along at least one edge



Figure 3D.9 Communal open space and public domain should be readily visible from habitable rooms and private open space areas while maintaining visual privacy



Figure 3D.10 Community gardens incorporated into residential developments foster interaction amongst residents of all ages

Objective 3D-2

Communal open space is designed to allow for a range of activities, respond to site conditions and be attractive and inviting

Design guidance

Facilities are provided within communal open spaces and common spaces for a range of age groups (see also 4F Common circulation and spaces), incorporating some of the following elements:

- seating for individuals or groups
- barbecue areas
- play equipment or play areas
- swimming pools, gyms, tennis courts or common rooms

The location of facilities responds to microclimate and site conditions with access to sun in winter, shade in summer and shelter from strong winds and down drafts

Visual impacts of services should be minimised, including location of ventilation duct outlets from basement car parks, electrical substations and detention tanks

Objective 3D-3

Communal open space is designed to maximise safety

Design guidance

Communal open space and the public domain should be readily visible from habitable rooms and private open space areas while maintaining visual privacy. Design solutions may include:

- bay windows
- corner windows
- balconies

Communal open space should be well lit

Where communal open space/facilities are provided for children and young people they are safe and contained

3D Communal and public open space



Figure 3D.11 Attractive and inviting communal open spaces with good solar access should be provided



Figure 3D.12 This communal courtyard provides gathering spaces, seating facilities, pergolas and barbecue facilities for residents



Figure 3D.13 This semi-public courtyard connects to the surrounding inner-city neighbourhood and offers a central water feature, seating and convenient pedestrian through-site links

Objective 3D-4

Public open space, where provided, is responsive to the existing pattern and uses of the neighbourhood

Design guidance

The public open space should be well connected with public streets along at least one edge

The public open space should be connected with nearby parks and other landscape elements

Public open space should be linked through view lines, pedestrian desire paths, termination points and the wider street grid

Solar access should be provided year round along with protection from strong winds

Opportunities for a range of recreational activities should be provided for people of all ages

A positive address and active frontages should be provided adjacent to public open space

Boundaries should be clearly defined between public open space and private areas

3E Deep soil zones

Deep soil zones are areas of soil not covered by buildings or structures within a development. They exclude basement car parks, services, swimming pools, tennis courts and impervious surfaces including car parks, driveways and roof areas.

Deep soil zones have important environmental benefits, such as allowing infiltration of rain water to the water table and reducing stormwater runoff, promoting healthy growth of large trees with large canopies and protecting existing mature trees which assist with temperature reduction in urban environments. Deep soil zones may be constrained by the size of the lot or the location of a proposed development. To provide shade and amenity for residents they can be co-located with communal open space.

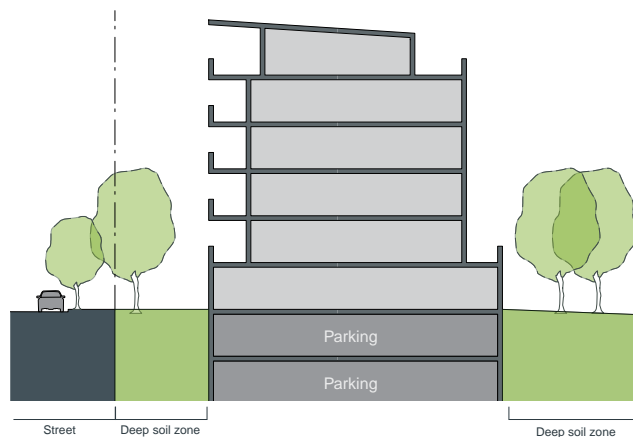

Figure 3E.1 Opportunities for deep soil zones are increased when parking levels are contained within the building footprint

Table 2 Suggested soil volumes on sites with sand, clay, alluvial, transition and disturbed soils

Tree size	Height	Spread	Soil volume
Large trees	13-18m	16m	80m ³
Medium tree	9-12m	8m	35m ³
Small tree	6-8m	4m	15m ³

Note: On sandy sites with reduced soil volumes, the number of trees planted is proportional to the available soil volume

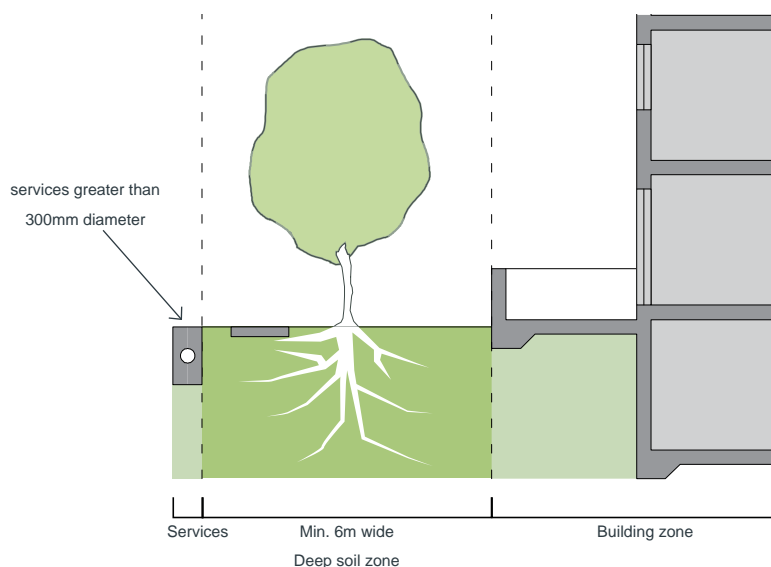

Figure 3E.2 Diagram showing the minimum dimension of deep soil zones for sites greater than 1,500m²



Figure 3E.3 Deep soil zones promote the growth of larger trees which improve amenity and local microclimate

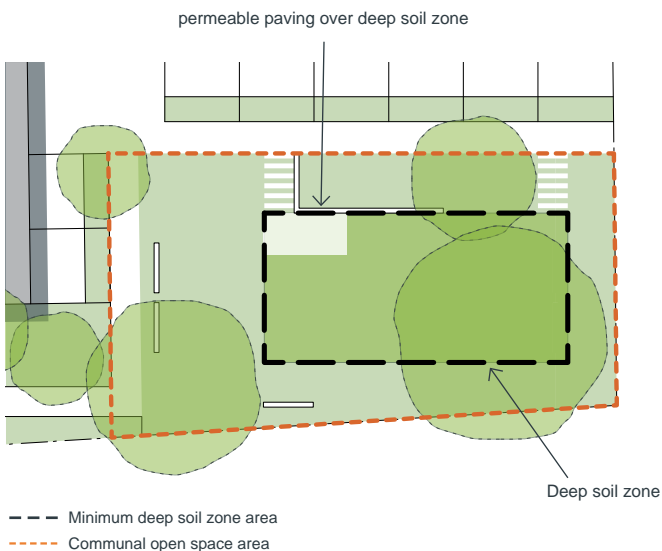

Figure 3E.4 Pedestrian pathways and paving which is specifically designed for tree root growth can occupy up to 10% of the deep soil zone

Objective 3E-1

Deep soil zones provide areas on the site that allow for and support healthy plant and tree growth. They improve residential amenity and promote management of water and air quality

Design criteria

1. Deep soil zones are to meet the following minimum requirements:

Site area	Minimum dimensions	Deep soil zone (% of site area)
less than 650m ²	-	7%
650m ² - 1,500m ²	3m	
greater than 1,500m ²	6m	
greater than 1,500m ² with significant existing tree cover	6m	

Design guidance

On some sites it may be possible to provide larger deep soil zones, depending on the site area and context:

- 10% of the site as deep soil on sites with an area of 650m² - 1,500m²
- 15% of the site as deep soil on sites greater than 1,500m²

Deep soil zones should be located to retain existing significant trees and to allow for the development of healthy root systems, providing anchorage and stability for mature trees. Design solutions may include:

- basement and sub basement car park design that is consolidated beneath building footprints
- use of increased front and side setbacks
- adequate clearance around trees to ensure long term health
- co-location with other deep soil areas on adjacent sites to create larger contiguous areas of deep soil

Achieving the design criteria may not be possible on some sites including where:

- the location and building typology have limited or no space for deep soil at ground level (e.g. central business district, constrained sites, high density areas, or in centres)
- there is 100% site coverage or non-residential uses at ground floor level

Where a proposal does not achieve deep soil requirements, acceptable stormwater management should be achieved and alternative forms of planting provided such as on structure

3F Visual privacy

Visual privacy allows residents within an apartment development and on adjacent properties to use their private spaces without being overlooked. It balances the need for views and outlook with the need for privacy. In higher density developments it also assists to increase overall amenity.

Visual privacy balances site and context specific design solutions with views, outlook, ventilation and solar access. The adjacent context, site configuration, topography, the scale of the development and the apartment layout all need to be considered.

Degrees of privacy are also influenced by a number of factors including the activities of each of the spaces where overlooking may occur, the times and frequency these spaces are being used, the expectations of occupants for privacy and their ability to control overlooking with screening devices.



Figure 3F.1 Visual privacy is an important factor for residential amenity. The siting of buildings needs to ensure adequate separation between apartments

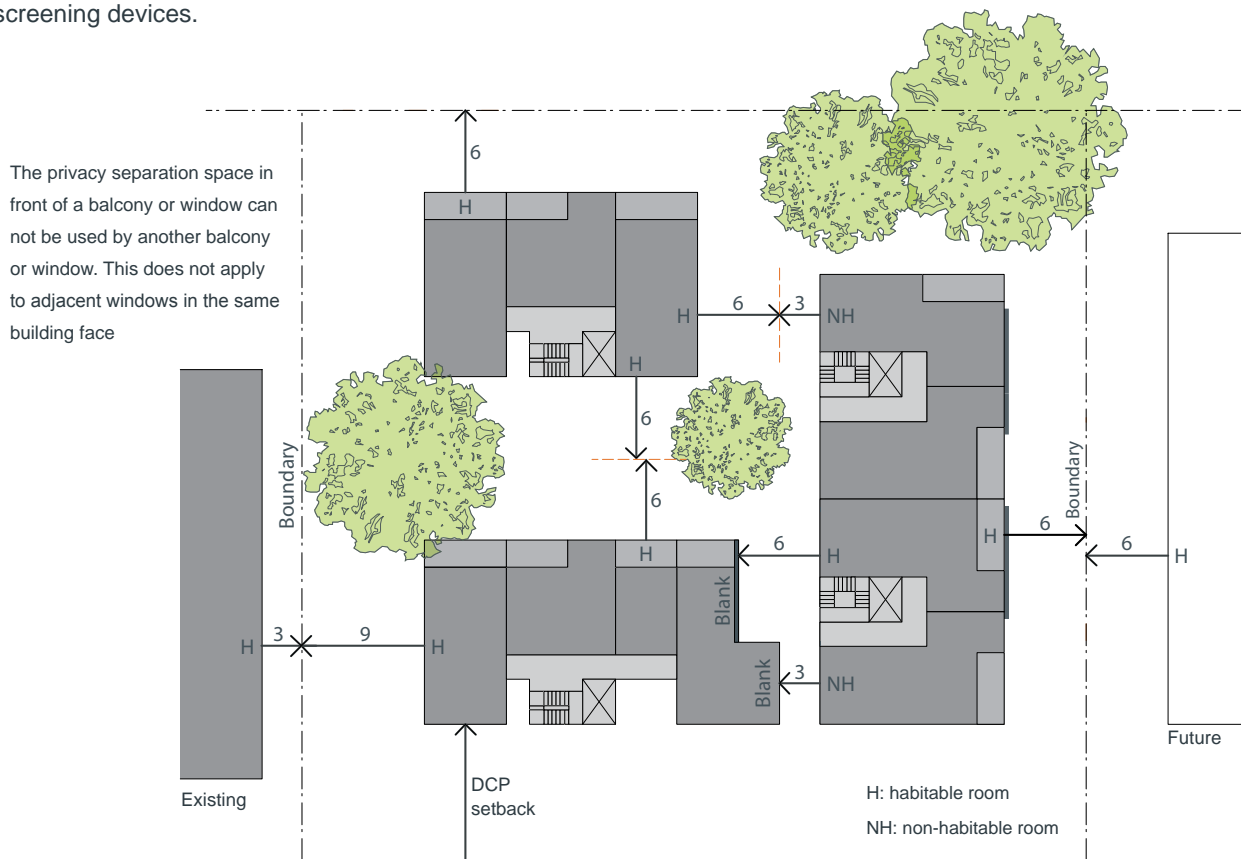

Figure 3F.2 Any one development will have a variety of visual privacy conditions to be accommodated. Section A (Figure 3F.4) shows separation distances between apartments within the same site

Objective 3F-1

Adequate building separation distances are shared equitably between neighbouring sites, to achieve reasonable levels of external and internal visual privacy

Design criteria

- Separation between windows and balconies is provided to ensure visual privacy is achieved. Minimum required separation distances from buildings to the side and rear boundaries are as follows:

Building height	Habitable rooms and balconies	Non-habitable rooms
up to 12m (4 storeys)	6m	3m
up to 25m (5-8 storeys)	9m	4.5m
over 25m (9+ storeys)	12m	6m

Note: Separation distances between buildings on the same site should combine required building separations depending on the type of room (see figure 3F.2)

Gallery access circulation should be treated as habitable space when measuring privacy separation distances between neighbouring properties

Design guidance

Generally one step in the built form as the height increases due to building separations is desirable. Additional steps should be careful not to cause a 'ziggurat' appearance

For residential buildings next to commercial buildings, separation distances should be measured as follows:

- for retail, office spaces and commercial balconies use the habitable room distances
- for service and plant areas use the non-habitable room distances

New development should be located and oriented to maximise visual privacy between buildings on site and for neighbouring buildings. Design solutions include:

- site layout and building orientation to minimise privacy impacts (see also section 3B Orientation)
- on sloping sites, apartments on different levels have appropriate visual separation distances (see figure 3F.4)

Apartment buildings should have an increased separation distance of 3m (in addition to the requirements set out in design criteria 1) when adjacent to a different zone that permits lower density residential development to provide for a transition in scale and increased landscaping (figure 3F.5)

Direct lines of sight should be avoided for windows and balconies across corners

No separation is required between blank walls

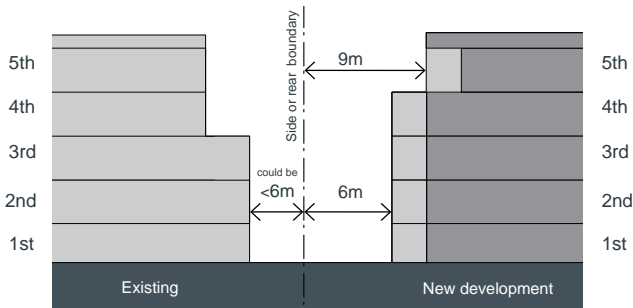

Figure 3F.3 New development adjacent to existing buildings should provide adequate separation distances to the boundary in accordance with the design criteria

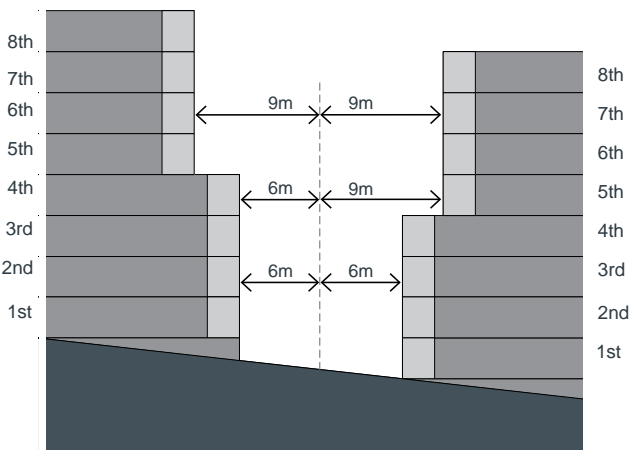

Figure 3F.4 Within the same site, minimum separation should be shared equitably between buildings. On sloping sites, appropriate separation distances ensure visual privacy for apartments on different levels

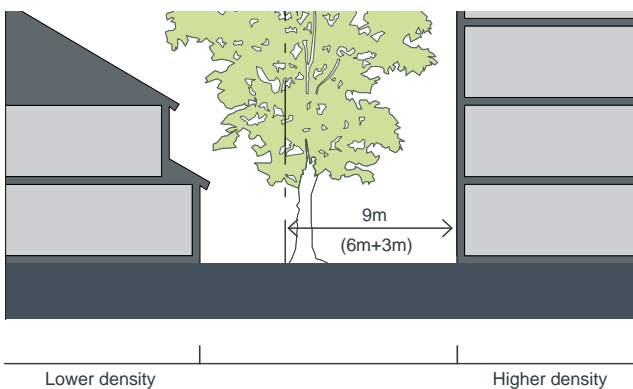
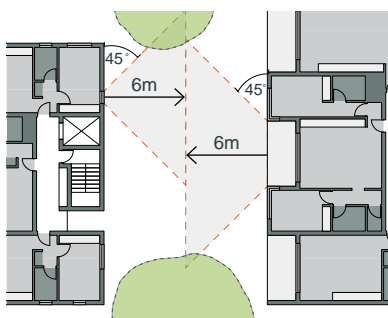

Figure 3F.5 To resolve amenity impacts, apartment buildings should increase the building separation distance (+3m) when adjacent to a different zone that permits lower density residential development

3F Visual privacy

Conditions within a development

Habitable to habitable rooms



Habitable to non-habitable rooms

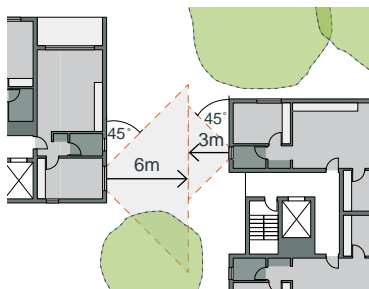

Boundary conditions

Habitable to habitable rooms

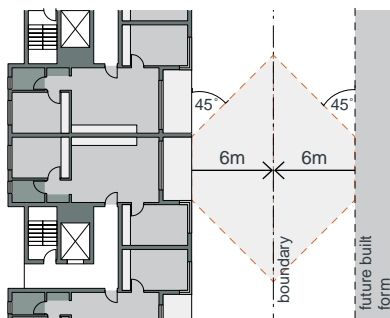

Habitable to non-compliant existing

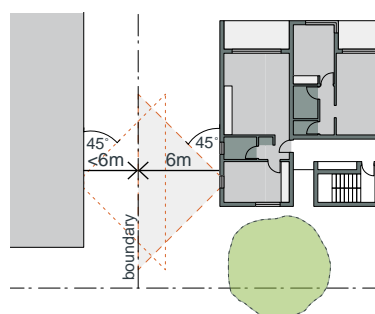

Blank wall conditions

To habitable rooms

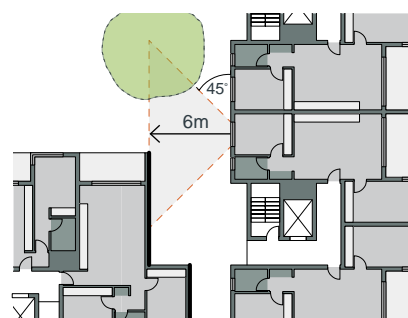

To non-habitable rooms

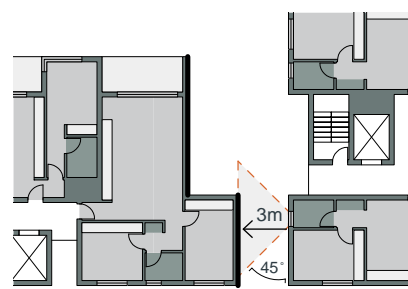

Figure 3F.6 Diagrams showing different privacy interface conditions



Figure 3F.7 Solid walls with non-habitable room windows are used for end elevations to manage privacy impacts between buildings. Solid balconies at lower levels provide better privacy from the street



Figure 3F.8 Well designed fences and balconies provide privacy to apartments when viewed from the public domain or adjacent apartment buildings



Figure 3F.9 Fencing of ground floor apartments should not be solid to allow for surveillance of common open space and the public domain

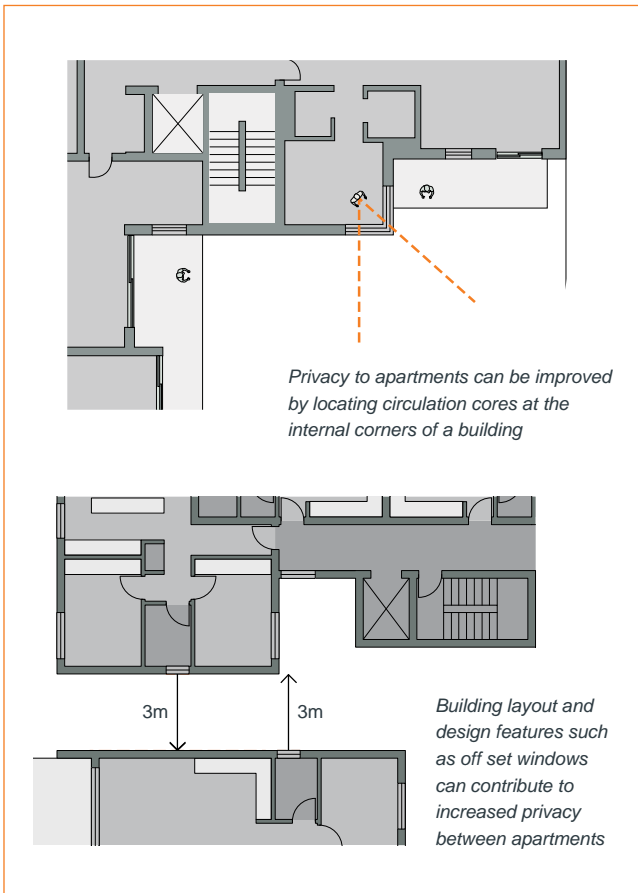

Figure 3F.10 Examples of solutions to increase privacy
Note: building separations are shown for up to 12m (4 storeys)

Objective 3F-2

Site and building design elements increase privacy without compromising access to light and air and balance outlook and views from habitable rooms and private open space

Design guidance

Communal open space, common areas and access paths should be separated from private open space and windows to apartments, particularly habitable room windows. Design solutions may include:

- setbacks
- solid or partially solid balustrades to balconies at lower levels
- fencing and/or trees and vegetation to separate spaces
- screening devices
- bay windows or pop out windows to provide privacy in one direction and outlook in another
- raising apartments/private open space above the public domain or communal open space
- planter boxes incorporated into walls and balustrades to increase visual separation
- pergolas or shading devices to limit overlooking of lower apartments or private open space
- on constrained sites where it can be demonstrated that building layout opportunities are limited, fixed louvres or screen panels to windows and/or balconies

Bedrooms, living spaces and other habitable rooms should be separated from gallery access and other open circulation space by the apartment's service areas

Balconies and private terraces should be located in front of living rooms to increase internal privacy

Windows should be offset from the windows of adjacent buildings

Recessed balconies and/or vertical fins should be used between adjacent balconies

3G Pedestrian access and entries

Good pedestrian access delivers high quality, equitable, safe and pleasant walking environments along the street, into the development and to individual apartments. Pedestrian access and entries must be priorities over vehicle access.

Building entries provide a connection with the public space and an address for a building or group of buildings. The design of building entries and their integration with the building and landscape design contributes to the identity of the building and the character of the streetscape. Building entries may lead into a common entry or directly into the private space of an apartment.



Figure 3G.2 Breaks between buildings, colour and landscaping can be combined to help identify building entries

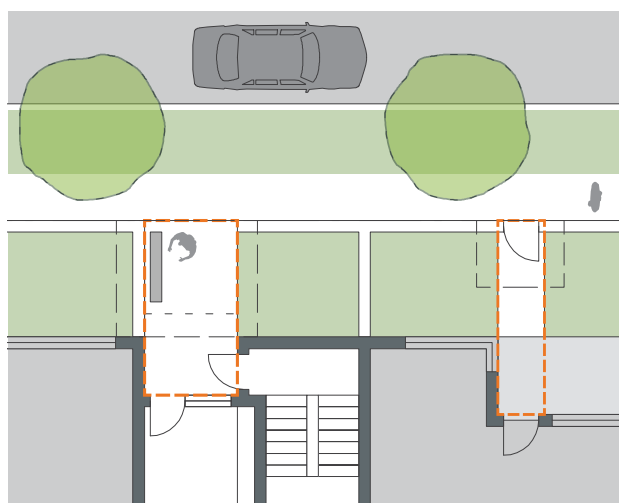

Figure 3G.1 Successful building entries define public and private space, are clearly identifiable and activate the street



Figure 3G.3 The use of colour of this building entry contrasts with the facade and surrounding landscape setting



Figure 3G.4 Features such as awnings, blade walls and signage contribute to building entries that are clearly identifiable from the street



Figure 3G.5 Pedestrian through-site links need to be direct with clear sight lines to each end



Figure 3G.6 Windows and balconies should overlook through-site connections to provide passive surveillance

Objective 3G-1

Building entries and pedestrian access connects to and addresses the public domain

Design guidance

Multiple entries (including communal building entries and individual ground floor entries) should be provided to activate the street edge

Entry locations relate to the street and subdivision pattern and the existing pedestrian network

Building entries should be clearly identifiable and communal entries should be clearly distinguishable from private entries

Where street frontage is limited and multiple buildings are located on the site, a primary street address should be provided with clear sight lines and pathways to secondary building entries

Objective 3G-2

Access, entries and pathways are accessible and easy to identify

Design guidance

Building access areas including lift lobbies, stairwells and hallways should be clearly visible from the public domain and communal spaces

The design of ground floors and underground car parks minimise level changes along pathways and entries

Steps and ramps should be integrated into the overall building and landscape design

For large developments 'way finding' maps should be provided to assist visitors and residents (see figure 4T.3)

For large developments electronic access and audio/video intercom should be provided to manage access

Objective 3G-3

Large sites provide pedestrian links for access to streets and connection to destinations

Design guidance

Pedestrian links through sites facilitate direct connections to open space, main streets, centres and public transport

Pedestrian links should be direct, have clear sight lines, be overlooked by habitable rooms or private open spaces of dwellings, be well lit and contain active uses, where appropriate

3H Vehicle access

The location, type and design of vehicle access points have significant impacts on the streetscape, the site layout and the building facade design. It is important that vehicle access is integrated with site planning from an early stage to balance any potential conflicts with traffic patterns, streetscape elements and safe pedestrian access.



Figure 3H.1 The impact of vehicle access points on the street can be minimised by locating them on secondary frontages

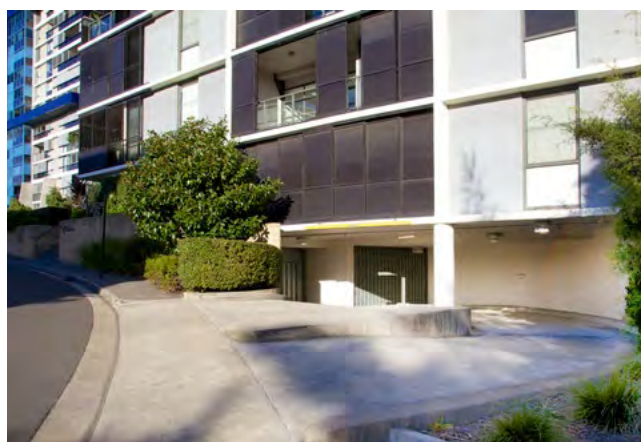

Figure 3H.2 Clear sightlines help to keep pedestrians safe. Locating entries to car parks at the lowest level of the site reduces ramp length



Figure 3H.3 Vehicle and pedestrian access should be clearly separated to improve pedestrian safety and comfort



Figure 3H.4 The visual impact of vehicle entries can be minimised by an offset alignment of the driveway and screen planting



Figure 3H.5 Where possible vehicle access points should not dominate the streetscape and be limited to the minimum width possible

Objective 3H-1

Vehicle access points are designed and located to achieve safety, minimise conflicts between pedestrians and vehicles and create high quality streetscapes

Design guidance

Car park access should be integrated with the building's overall facade. Design solutions may include:

- the materials and colour palette to minimise visibility from the street
- security doors or gates at entries that minimise voids in the facade
- where doors are not provided, the visible interior reflects the facade design and the building services, pipes and ducts are concealed

Car park entries should be located behind the building line

Vehicle entries should be located at the lowest point of the site minimising ramp lengths, excavation and impacts on the building form and layout

Car park entry and access should be located on secondary streets or lanes where available

Vehicle standing areas that increase driveway width and encroach into setbacks should be avoided

Access point locations should avoid headlight glare to habitable rooms

Adequate separation distances should be provided between vehicle entries and street intersections

The width and number of vehicle access points should be limited to the minimum

Visual impact of long driveways should be minimised through changing alignments and screen planting

The need for large vehicles to enter or turn around within the site should be avoided

Garbage collection, loading and servicing areas are screened

Clear sight lines should be provided at pedestrian and vehicle crossings

Traffic calming devices such as changes in paving material or textures should be used where appropriate

Pedestrian and vehicle access should be separated and distinguishable. Design solutions may include:

- changes in surface materials
- level changes
- the use of landscaping for separation

3J Bicycle and car parking

Integrating car parking within apartment buildings has a significant impact on site planning, landscape and building design. On site parking can be located underground, above ground within a structure or at grade.

The location, form and organisation of parking is usually a balance of development feasibility, site constraints, local context, apartment types and regulatory car parking requirements. Deep soil zones, stormwater management and the retention of trees can also affect the size and shape of a car park footprint.

Parking requirements should be determined in relation to the availability, frequency and convenience of public transport or proximity to a centre in regional areas. Reduced requirements promote a reduction in car dependency and encourage walking, cycling and use of public transport. Provision of parking for alternative forms of transport such as car share vehicles, motorcycles and bicycles should also be considered. Where less car parking is provided, councils should not provide on street resident parking permits.

Table 3 Nominated regional centres for design criteria 1

Nominated regional centres

Albury, Ballina, Batemans Bay, Bathurst, Bega, Bowral, Cessnock, Charlestown, Coffs Harbour, Dapto, Dubbo, Glendale–Cardiff, Gosford, Goulburn, Grafton, Lismore, Maitland, Morisset, Newcastle, Nowra, Orange, Port Macquarie, Queanbeyan, Raymond Terrace, Shellharbour, Tamworth, Taree, Tuggerah–Wyong, Tweed Heads, Wagga Wagga, Warrawong and Wollongong



Figure 3J.1 This development provides green open space on top of the car park structure (top photo). The ground level facing the street is 'wrapped' with retail and commercial uses (bottom photo)



Figure 3J.2 Car share parking spaces that are conveniently located as part of apartment developments encourage reduced car ownership

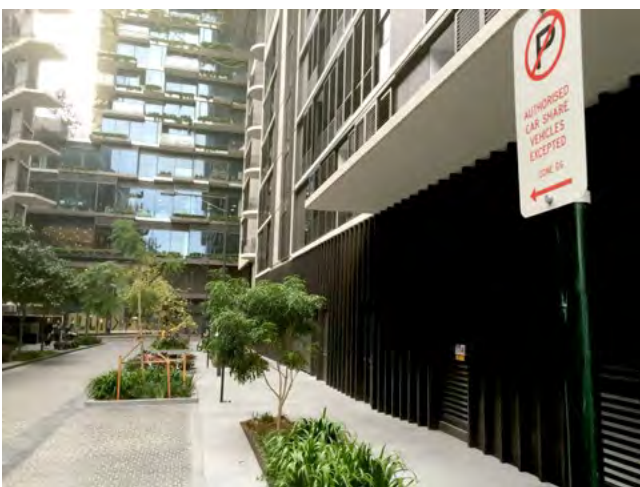

Figure 3J.3 Car share parking spaces can be provided in private areas of development for use by residents

Objective 3J-1

Car parking is provided based on proximity to public transport in metropolitan Sydney and centres in regional areas

Design criteria

- For development in the following locations:
 - on sites that are within 800 metres of a railway station or light rail stop in the Sydney Metropolitan Area; or
 - on land zoned, and sites within 400 metres of land zoned, B3 Commercial Core, B4 Mixed Use or equivalent in a nominated regional centre

the minimum car parking requirement for residents and visitors is set out in the Guide to Traffic Generating Developments, or the car parking requirement prescribed by the relevant council, whichever is less

The car parking needs for a development must be provided off street

Design guidance

Where a car share scheme operates locally, provide car share parking spaces within the development. Car share spaces, when provided, should be on site

Where less car parking is provided in a development, council should not provide on street resident parking permits

Objective 3J-2

Parking and facilities are provided for other modes of transport

Design guidance

Conveniently located and sufficient numbers of parking spaces should be provided for motorbikes and scooters

Secure undercover bicycle parking should be provided that is easily accessible from both the public domain and common areas

Conveniently located charging stations are provided for electric vehicles, where desirable

3J Bicycle and car parking



Figure 3J.4 Permeable roller doors allow for natural ventilation and improve the safety of car parking areas by enabling passive surveillance



Figure 3J.5 Bicycle parking for residents should be secure and easy to access from common areas



Figure 3J.6 Natural ventilation to the underground car park is integrated into the landscape design of this development



Figure 3J.7 An example of a car wash bay integrated into the basement car park of a residential apartment building



Figure 3J.8 Efficient car park layouts and ramp design should be used



Figure 3J.9 Car wash bays can be accessed without crossing car parking spaces



Figure 3J.10 Car parking is well organised and used a logical, clearly marked structure

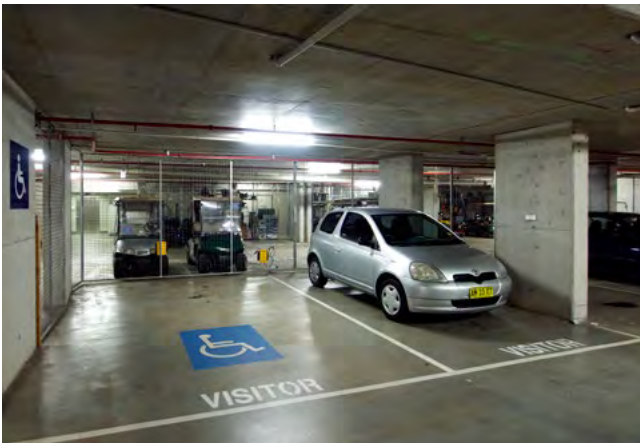

Figure 3J.11 Visitor car parking is provided within car parks



Figure 3J.12 Where car parks are located above ground and visible from public or common areas, they should be partially or fully screened from view

Objective 3J-3

Car park design and access is safe and secure

Design guidance

Supporting facilities within car parks, including garbage, plant and switch rooms, storage areas and car wash bays can be accessed without crossing car parking spaces

Direct, clearly visible and well lit access should be provided into common circulation areas

A clearly defined and visible lobby or waiting area should be provided to lifts and stairs

For larger car parks, safe pedestrian access should be clearly defined and circulation areas have good lighting, colour, line marking and/or bollards

Objective 3J-4

Visual and environmental impacts of underground car parking are minimised

Design guidance

Excavation should be minimised through efficient car park layouts and ramp design

Car parking layout should be well organised, using a logical, efficient structural grid and double loaded aisles

Protrusion of car parks should not exceed 1m above ground level. Design solutions may include stepping car park levels or using split levels on sloping sites

Natural ventilation should be provided to basement and sub basement car parking areas

Ventilation grills or screening devices for car parking openings should be integrated into the facade and landscape design

3J Bicycle and car parking



Figure 3J.13 Landscaped on-street parking can enhance streetscape character



Figure 3J.14 Landscaping of on-street parking reduces visual impact while providing amenity and environmental benefits such as shade, reduced surface temperatures and water management



Figure 3J.15 The impact of car parking and vehicular access points on the streetscape should be minimised



Figure 3J.16 Screening can be used to integrate above ground car parking with the facade

Photo: Michael Zanarolo

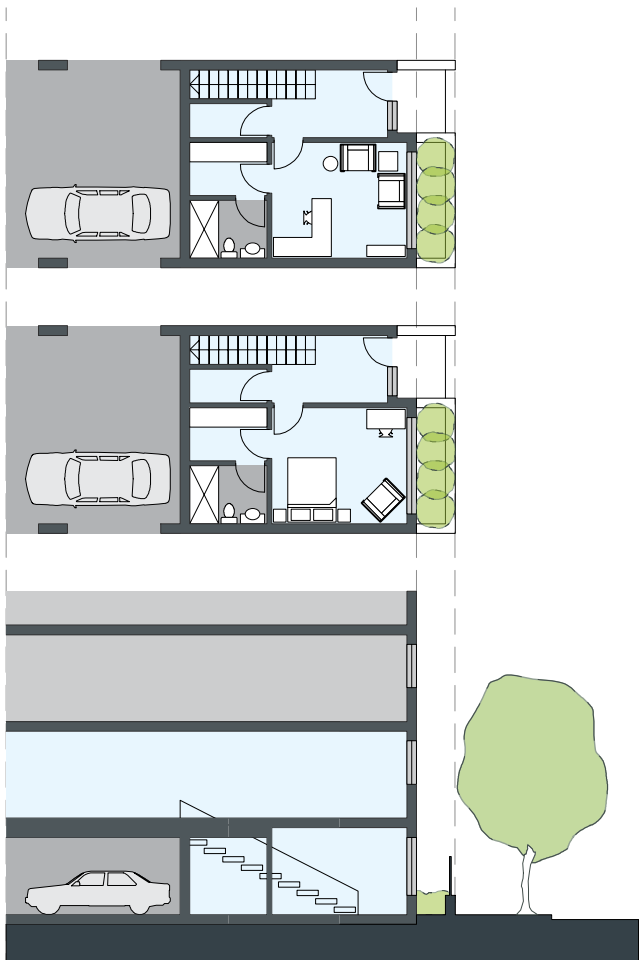

Figure 3J.17 Above ground parking should be concealed behind the building facade and wrapped with other uses along the primary street frontage, such as retail, commercial or two storey SOHO units

Objective 3J-5

Visual and environmental impacts of on-grade car parking are minimised

Design guidance

On-grade car parking should be avoided

Where on-grade car parking is unavoidable, the following design solutions are used:

- parking is located on the side or rear of the lot away from the primary street frontage
- cars are screened from view of streets, buildings, communal and private open space areas
- safe and direct access to building entry points is provided
- parking is incorporated into the landscape design of the site, by extending planting and materials into the car park space
- stormwater run-off is managed appropriately from car parking surfaces
- bio-swales, rain gardens or on site detention tanks are provided, where appropriate
- light coloured paving materials or permeable paving systems are used and shade trees are planted between every 4-5 parking spaces to reduce increased surface temperatures from large areas of paving

Objective 3J-6

Visual and environmental impacts of above ground enclosed car parking are minimised

Design guidance

Exposed parking should not be located along primary street frontages

Screening, landscaping and other design elements including public art should be used to integrate the above ground car parking with the facade. Design solutions may include:

- car parking that is concealed behind the facade, with windows integrated into the overall facade design (approach should be limited to developments where a larger floor plate podium is suitable at lower levels)
- car parking that is 'wrapped' with other uses, such as retail, commercial or two storey Small Office/Home Office (SOHO) units along the street frontage (see figure 3J.9)

Positive street address and active frontages should be provided at ground level





Part 4

Designing the building

This part addresses the design of apartment buildings in more detail. It focuses on building form, layout, functionality, landscape design, environmental performance and residential amenity. It is to be used during the design process and in the preparation and assessment of development applications

Amenity

- 4A Solar and daylight access
- 4B Natural ventilation
- 4C Ceiling heights
- 4D Apartment size and layout
- 4E Private open space and balconies
- 4F Common circulation and spaces
- 4G Storage
- 4H Acoustic privacy
- 4J Noise and pollution

Configuration

- 4K Apartment mix
- 4L Ground floor apartments
- 4M Facades
- 4N Roof design
- 4O Landscape design
- 4P Planting on structures
- 4Q Universal design
- 4R Adaptive reuse
- 4S Mixed use
- 4T Awnings and signage

Performance

- 4U Energy efficiency
- 4V Water management and conservation
- 4W Waste management
- 4X Building maintenance

4A Solar and daylight access

Solar and daylight access are important for apartment buildings, reducing the reliance on artificial lighting and heating, improving energy efficiency and residential amenity through pleasant conditions to live and work.

Solar access is the ability of a building to receive direct sunlight without the obstruction from other buildings or impediments, not including trees. Sunlight is direct beam

radiation from the sun. Daylight consists of sunlight and diffuse light from the sky. Daylight changes with the time of day, season and weather conditions.

Access to sunlight for habitable rooms and private open space is measured at mid winter (21 June) as this is when the sun is lowest in the sky, representing the 'worst case' scenario for solar access.

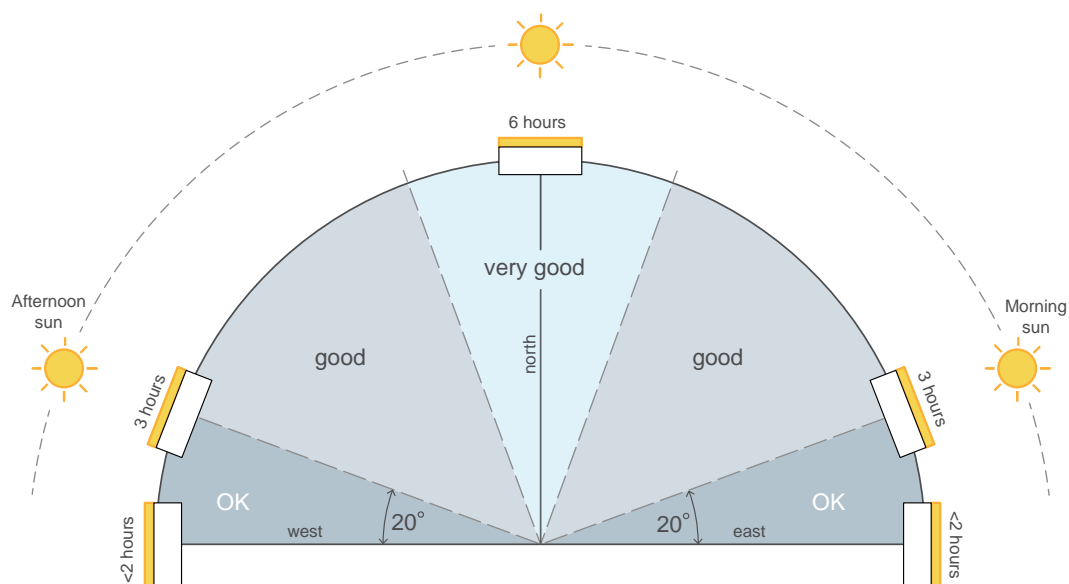

Figure 4A.1 The hours of sunlight that can be expected in mid winter are directly related to the orientation of the facade. This diagram shows the optimal orientation for habitable rooms and balconies
Note: An additional design and assessment tool is provided at Appendix 5 to assist in confirming the level of sunlight access to apartments

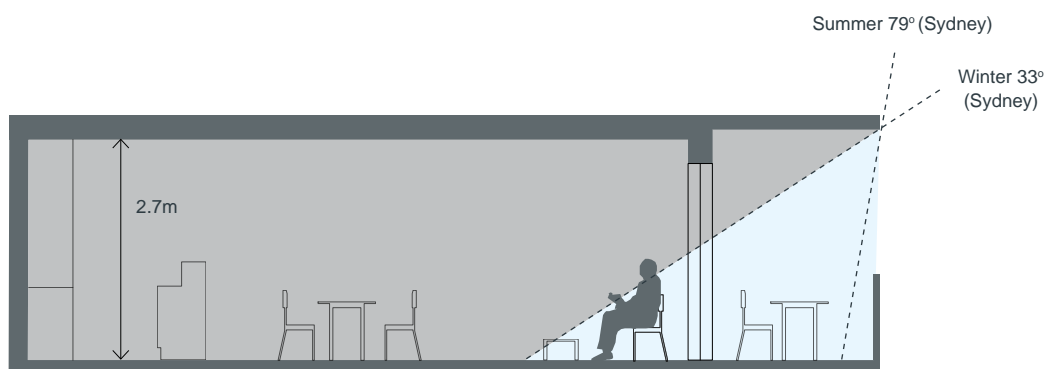

Figure 4A.2 Shading devices on balconies should shade summer sun and allow winter sun access to living areas



Figure 4A.3 Horizontal louvres are most effective on north facing elevations and achieve summer shade and winter sun access

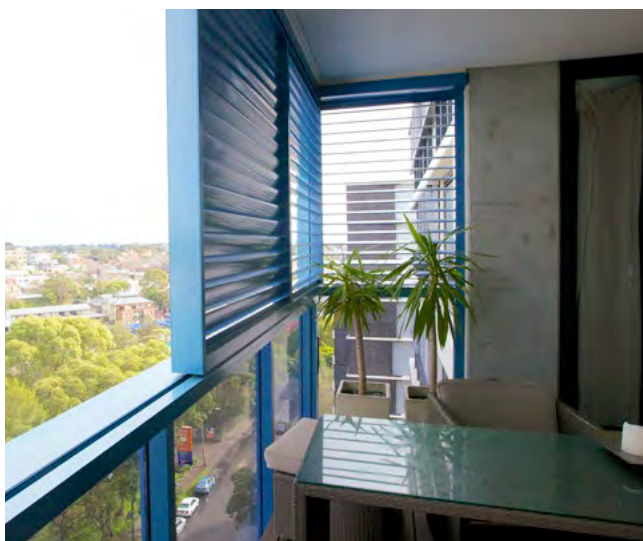

Figure 4A.4 These operable screens can be adjusted by residents according to the season, weather conditions and time of day

Objective 4A-1

To optimise the number of apartments receiving sunlight to habitable rooms, primary windows and private open space

Design criteria

1. Living rooms and private open spaces of at least 70% of apartments in a building receive a minimum of 2 hours direct sunlight between 9 am and 3 pm at mid winter in the Sydney Metropolitan Area and in the Newcastle and Wollongong local government areas
2. In all other areas, living rooms and private open spaces of at least 70% of apartments in a building receive a minimum of 3 hours direct sunlight between 9 am and 3 pm at mid winter
3. A maximum of 15% of apartments in a building receive no direct sunlight between 9 am and 3 pm at mid winter

Design guidance

The design maximises north aspect and the number of single aspect south facing apartments is minimised

Single aspect, single storey apartments should have a northerly or easterly aspect

Living areas are best located to the north and service areas to the south and west of apartments

To optimise the direct sunlight to habitable rooms and balconies a number of the following design features are used:

- dual aspect apartments
- shallow apartment layouts
- two storey and mezzanine level apartments
- bay windows

To maximise the benefit to residents of direct sunlight within living rooms and private open spaces, a minimum of 1m² of direct sunlight, measured at 1m above floor level, is achieved for at least 15 minutes

Achieving the design criteria may not be possible on some sites. This includes:

- where greater residential amenity can be achieved along a busy road or rail line by orientating the living rooms away from the noise source
- on south facing sloping sites
- where significant views are oriented away from the desired aspect for direct sunlight

Design drawings need to demonstrate how site constraints and orientation preclude meeting the design criteria and how the development meets the objective

4A Solar and daylight access



Figure 4A.5 At least 70% of all apartments in a building should receive a minimum of 2 hours direct sunlight in mid winter in the Sydney Metropolitan Area and in the Newcastle and Wollongong local government areas, and at least 3 hours direct sunlight elsewhere in NSW

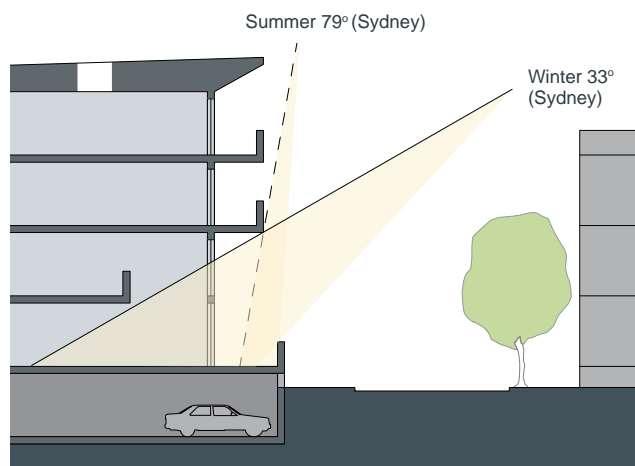

Figure 4A.6 Double height apartments and skylights on roofs increase sunlight and daylight access
Note: angles will vary slightly for different locations in NSW



Figure 4A.7 Vertical louvres are an effective sun management technique for east and west-facing windows and balconies



Figure 4A.8 Trees help shade building facades. For east and west facing facades consider planting deciduous species



Figure 4A.9 Courtyards can provide for daylight access to common areas. For habitable rooms of apartments, they should only be used as a secondary light source

Objective 4A-2

Daylight access is maximised where sunlight is limited

Design guidance

Courtyards, skylights and high level windows (with sills of 1,500mm or greater) are used only as a secondary light source in habitable rooms

Where courtyards are used :

- use is restricted to kitchens, bathrooms and service areas
- building services are concealed with appropriate detailing and materials to visible walls
- courtyards are fully open to the sky
- access is provided to the light well from a communal area for cleaning and maintenance
- acoustic privacy, fire safety and minimum privacy separation distances (see section 3F Visual privacy) are achieved

Opportunities for reflected light into apartments are optimised through:

- reflective exterior surfaces on buildings opposite south facing windows
- positioning windows to face other buildings or surfaces (on neighbouring sites or within the site) that will reflect light
- integrating light shelves into the design
- light coloured internal finishes

Objective 4A-3

Design incorporates shading and glare control, particularly for warmer months

Design guidance

A number of the following design features are used:

- balconies or sun shading that extend far enough to shade summer sun, but allow winter sun to penetrate living areas
- shading devices such as eaves, awnings, balconies, pergolas, external louvres and planting
- horizontal shading to north facing windows
- vertical shading to east and particularly west facing windows
- operable shading to allow adjustment and choice
- high performance glass that minimises external glare off windows, with consideration given to reduced tint glass or glass with a reflectance level below 20% (reflective films are avoided)

4B Natural ventilation

Natural ventilation is the movement of sufficient volumes of fresh air through an apartment to create a comfortable indoor environment. Sustainable design practice incorporates natural ventilation by responding to the local climate and reduces the need for mechanical ventilation and air conditioning. To achieve adequate natural ventilation, apartment design must address the orientation of the building, the configuration of apartments and the external building envelope.

Natural cross ventilation is achieved by apartments having more than one aspect with direct exposure to the prevailing winds, or windows located in significantly different pressure regions, rather than relying on purely wind driven air. Apartment layout and building depth have a close relationship with the ability of an apartment to be naturally ventilated. Generally as the building gets deeper, effective airflow reduces.

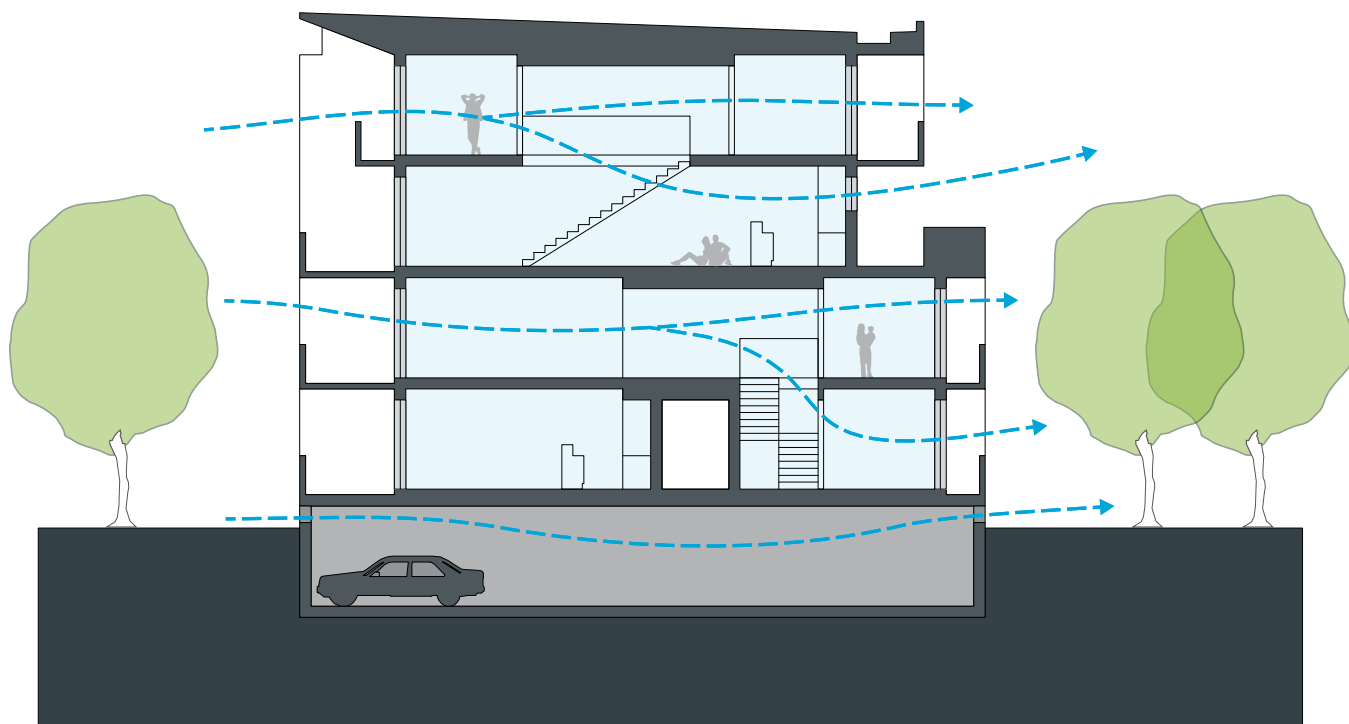

Figure 4B.1 Prevailing winds vary for different locations and depend on local conditions. For coastal areas in NSW, cooling sea breezes in summer tend to come from a north-easterly direction



Figure 4B.2 Operable balcony screens allow occupants to customise their environment and regulate access of natural light and ventilation

Objective 4B-1

All habitable rooms are naturally ventilated

Design guidance

The building's orientation maximises capture and use of prevailing breezes for natural ventilation in habitable rooms

Depths of habitable rooms support natural ventilation

The area of unobstructed window openings should be equal to at least 5% of the floor area served

Light wells are not the primary air source for habitable rooms

Doors and operable windows maximise natural ventilation opportunities by using the following design solutions:

- adjustable windows with large effective openable areas
- a variety of window types that provide safety and flexibility such as awnings and louvres
- windows which the occupants can reconfigure to funnel breezes into the apartment such as vertical louvres, casement windows and externally opening doors

Objective 4B-2

The layout and design of single aspect apartments maximises natural ventilation

Design guidance

Apartment depths are limited to maximise ventilation and airflow (see also figure 4D.3)

Natural ventilation to single aspect apartments is achieved with the following design solutions:

- primary windows are augmented with plenums and light wells (generally not suitable for cross ventilation)
- stack effect ventilation / solar chimneys or similar to naturally ventilate internal building areas or rooms such as bathrooms and laundries
- courtyards or building indentations have a width to depth ratio of 2:1 or 3:1 to ensure effective air circulation and avoid trapped smells

4B Natural ventilation

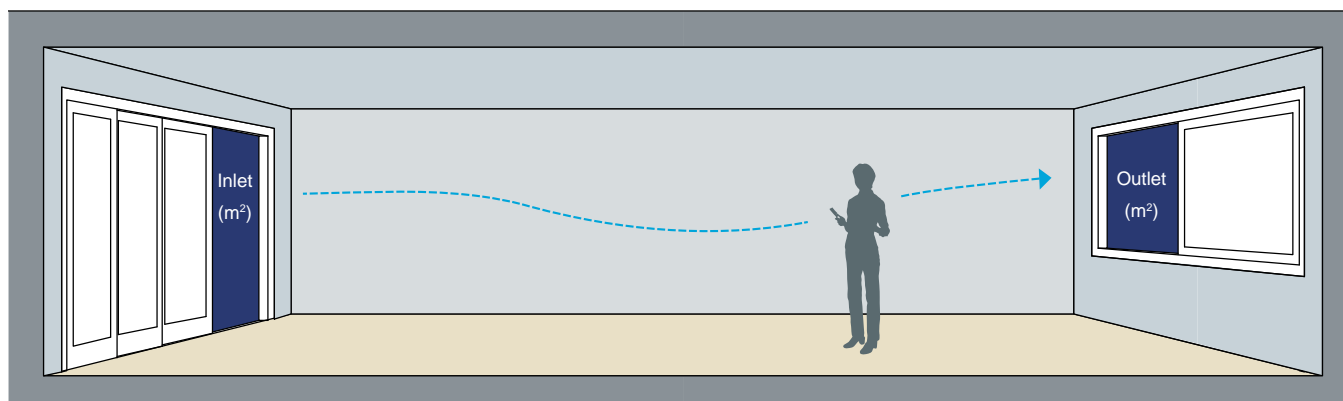

Figure 4B.3 Effective cross ventilation is achieved when the inlet and outlet have approximately the same area, allowing air to be drawn through the apartment using opposite air pressures on each side of the building

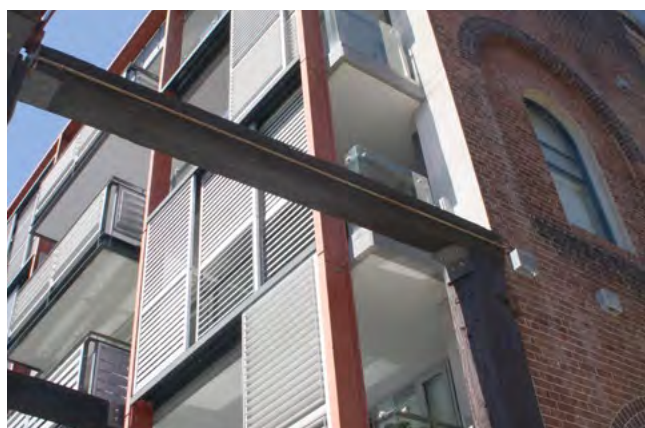

Figure 4B.4 Responding to the local climate reduces the need for mechanical ventilation and air conditioning



Figure 4B.5 Natural cross ventilation is facilitated by limited apartment depths and use of dual aspect apartments



Figure 4B.6 Natural ventilation is further enhanced by using generous window and door openings



Figure 4B.7 Operable louvres allow residents to regulate natural ventilation

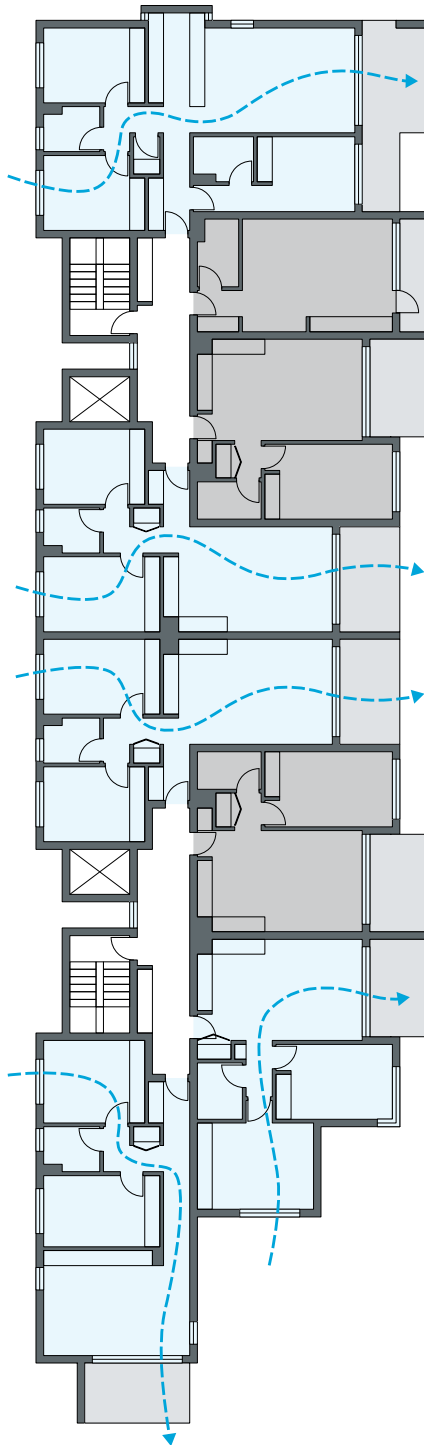

Figure 4B.8 The floor plan above demonstrates one approach for how five of a total of eight apartments achieve natural cross ventilation

Objective 4B-3

The number of apartments with natural cross ventilation is maximised to create a comfortable indoor environment for residents

Design criteria

1. At least 60% of apartments are naturally cross ventilated in the first nine storeys of the building. Apartments at ten storeys or greater are deemed to be cross ventilated only if any enclosure of the balconies at these levels allows adequate natural ventilation and cannot be fully enclosed
2. Overall depth of a cross-over or cross-through apartment does not exceed 18m, measured glass line to glass line

Design guidance

The building should include dual aspect apartments, cross through apartments and corner apartments and limit apartment depths

In cross-through apartments external window and door opening sizes/areas on one side of an apartment (inlet side) are approximately equal to the external window and door opening sizes/areas on the other side of the apartment (outlet side) (see figure 4B.4)

Apartments are designed to minimise the number of corners, doors and rooms that might obstruct airflow

Apartment depths, combined with appropriate ceiling heights, maximise cross ventilation and airflow

4C Ceiling heights

Ceiling height is measured internally from finished floor level to finished ceiling level. The height of a ceiling contributes to amenity within an apartment and the perception of space. Well designed and appropriately defined ceilings can create spatial interest and hierarchy in apartments.

Ceiling height is directly linked to achieving sufficient natural ventilation and daylight access to habitable rooms. The ground and first floor levels of mixed use apartment buildings should have increased ceiling heights to ensure their longer term adaptability for other uses.

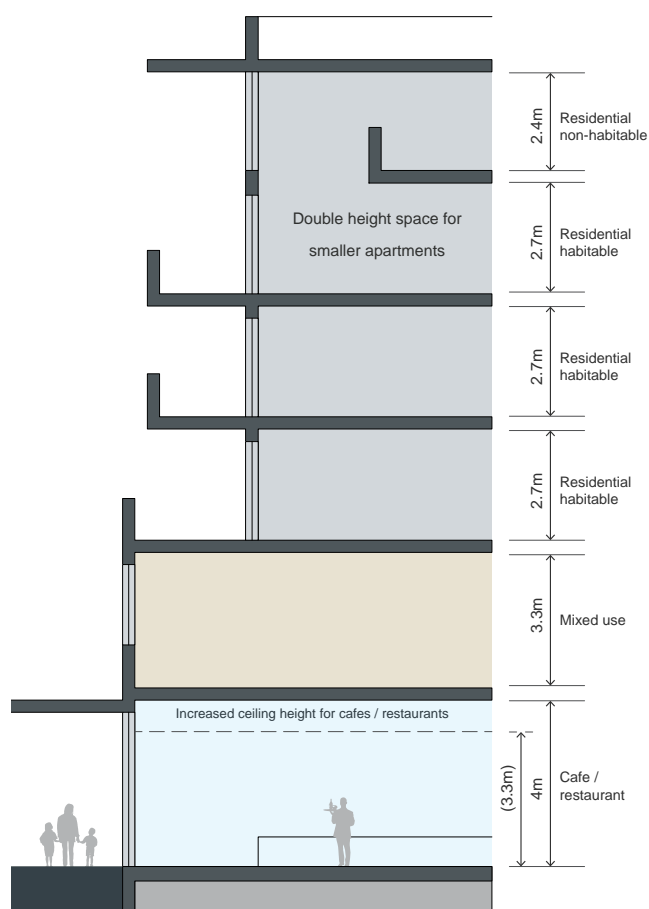

Figure 4C.1 Greater than minimum ceiling heights for retail and commercial floors of mixed use developments are encouraged to promote flexibility of use. Cafe and restaurant uses need greater minimum ceiling heights of 4m to allow for additional servicing needs

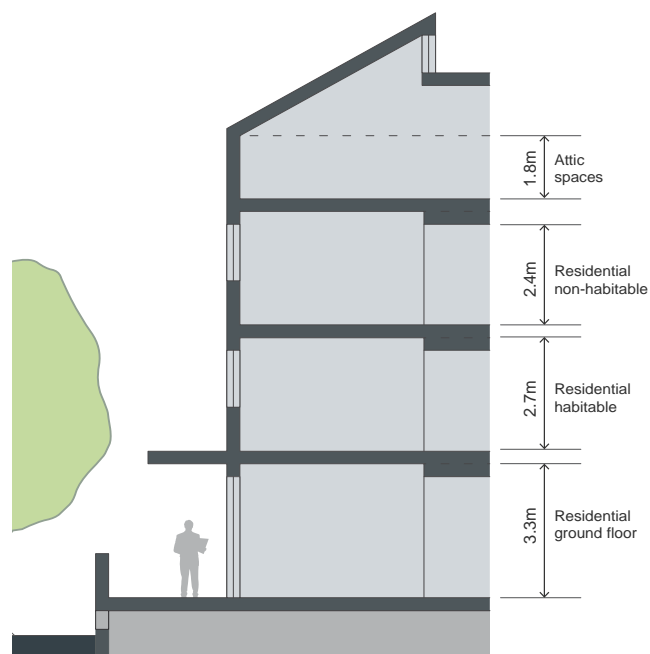

Figure 4C.2 Ceiling heights of minimum 2.7m help to achieve good daylight access and natural ventilation to residential apartments

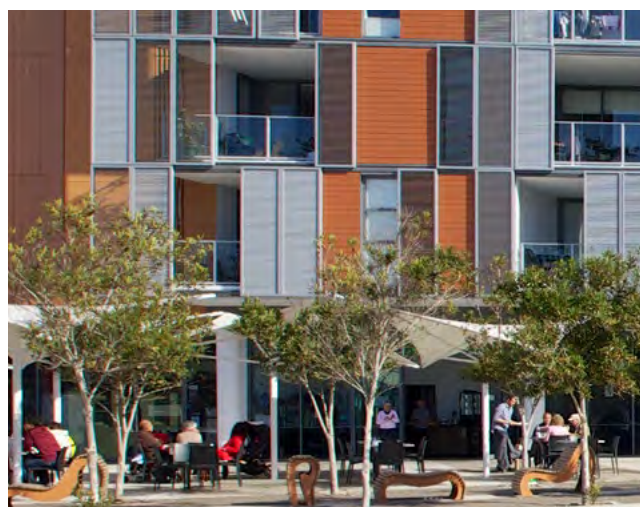

Figure 4C.3 Ground floors often need to accommodate a range of uses such as retail, cafes and restaurants, and should provide increased ceiling heights to allow for maximum flexibility of use



Figure 4C.4 Differing ceiling heights are an opportunity to provide visual interest in the building facade

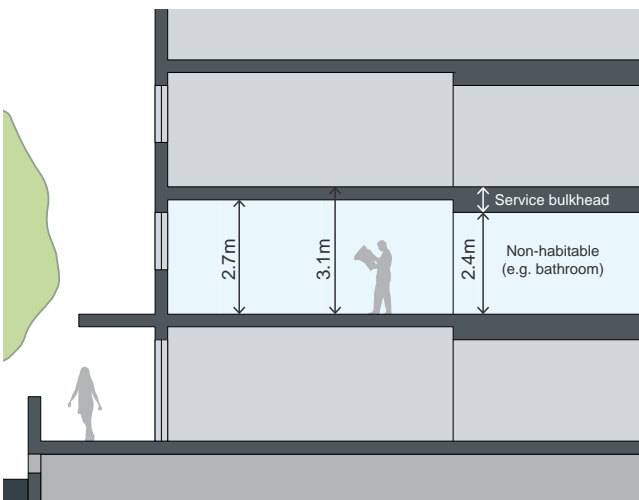

Figure 4C.5 Service bulkheads are wholly contained within non-habitable rooms and do not intrude into habitable spaces

Objective 4C-1

Ceiling height achieves sufficient natural ventilation and daylight access

Design criteria

1. Measured from finished floor level to finished ceiling level, minimum ceiling heights are:

Minimum ceiling height for apartment and mixed use buildings	
Habitable rooms	2.7m
Non-habitable	2.4m
For 2 storey apartments	2.7m for main living area floor 2.4m for second floor, where its area does not exceed 50% of the apartment area
Attic spaces	1.8m at edge of room with a 30 degree minimum ceiling slope
If located in mixed used areas	3.3m for ground and first floor to promote future flexibility of use

These minimums do not preclude higher ceilings if desired

Design guidance

Ceiling height can accommodate use of ceiling fans for cooling and heat distribution

Objective 4C-2

Ceiling height increases the sense of space in apartments and provides for well proportioned rooms

Design guidance

A number of the following design solutions can be used:

- the hierarchy of rooms in an apartment is defined using changes in ceiling heights and alternatives such as raked or curved ceilings, or double height spaces
- well proportioned rooms are provided, for example, smaller rooms feel larger and more spacious with higher ceilings
- ceiling heights are maximised in habitable rooms by ensuring that bulkheads do not intrude. The stacking of service rooms from floor to floor and coordination of bulkhead location above non-habitable areas, such as robes or storage, can assist

Objective 4C-3

Ceiling heights contribute to the flexibility of building use over the life of the building

Design guidance

Ceiling heights of lower level apartments in centres should be greater than the minimum required by the design criteria allowing flexibility and conversion to non-residential uses (see figure 4C.1)

4D Apartment size and layout

The layout of an apartment establishes the way rooms of different functions are arranged and located, the size of the rooms, the circulation between rooms and the degree of privacy for each room.

In addition, the layout directly impacts the quality of residential amenity by incorporating appropriate room shapes and window designs to deliver daylight and sunlight, natural ventilation, and acoustic and visual privacy. The apartment layout also includes private open space and conveniently located storage.

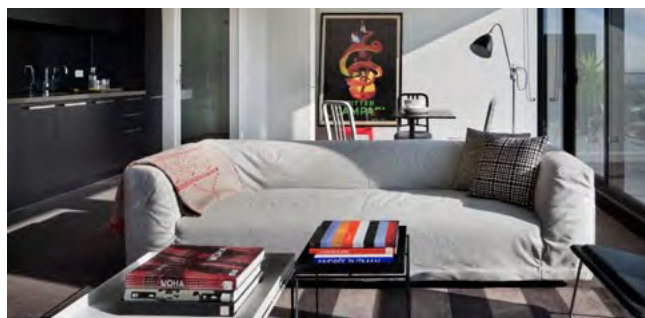

Figure 4D.1 This living area has a combined kitchen dining area that opens directly onto the balcony



Figure 4D.2 For open plan layouts, combining the living room, dining room and kitchen, the maximum room depth is 8 metres from a window

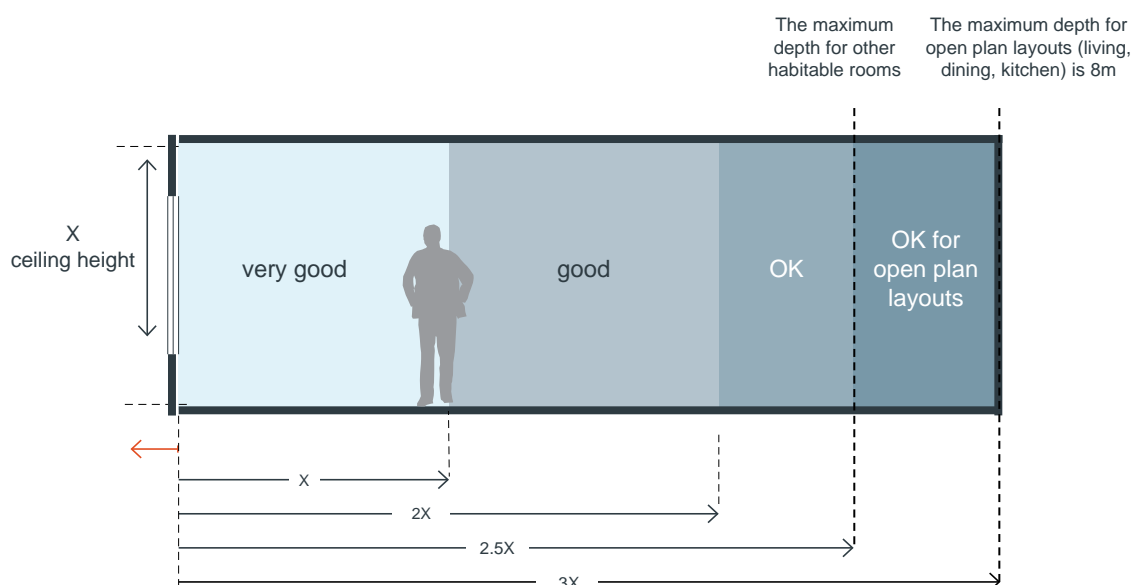
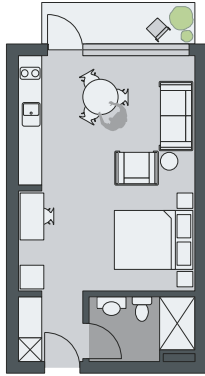

Figure 4D.3 The depth of a single aspect apartment relative to the ceiling height directly influences the quality of natural ventilation and daylight access. The maximum depth of open plan layouts that combine living, dining and kitchen spaces is 8 metres

Indicative layouts

studio



1 bedroom

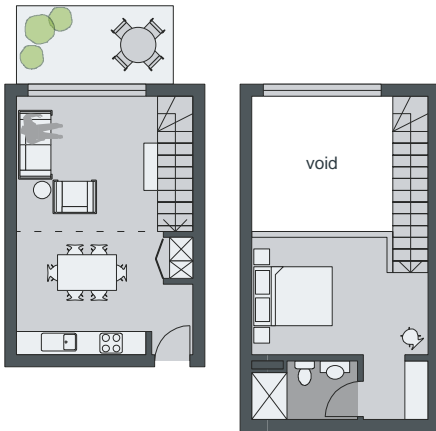

1 bedroom single aspect mezzanine

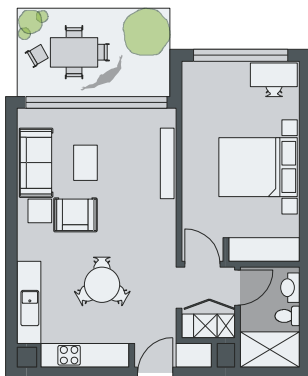

1 bedroom single aspect

Figure 4D.4 Diagrams showing indicative layouts for small apartments
Note: these do not represent the only solutions

Objective 4D-1

The layout of rooms within an apartment is functional, well organised and provides a high standard of amenity

Design criteria

1. Apartments are required to have the following minimum internal areas:

Apartment type	Minimum internal area
Studio	35m ²
1 bedroom	50m ²
2 bedroom	70m ²
3 bedroom	90m ²

The minimum internal areas include only one bathroom. Additional bathrooms increase the minimum internal area by 5m² each

A fourth bedroom and further additional bedrooms increase the minimum internal area by 12m² each

2. Every habitable room must have a window in an external wall with a total minimum glass area of not less than 10% of the floor area of the room. Daylight and air may not be borrowed from other rooms

Design guidance

Kitchens should not be located as part of the main circulation space in larger apartments (such as hallway or entry space)

A window should be visible from any point in a habitable room

Where minimum areas or room dimensions are not met apartments need to demonstrate that they are well designed and demonstrate the usability and functionality of the space with realistically scaled furniture layouts and circulation areas. These circumstances would be assessed on their merits

Objective 4D-2

Environmental performance of the apartment is maximised

Design criteria

1. Habitable room depths are limited to a maximum of 2.5 x the ceiling height
2. In open plan layouts (where the living, dining and kitchen are combined) the maximum habitable room depth is 8m from a window

Design guidance

Greater than minimum ceiling heights can allow for proportional increases in room depth up to the permitted maximum depths

All living areas and bedrooms should be located on the external face of the building

4D Apartment size and layout

Indicative layouts

2 bedroom

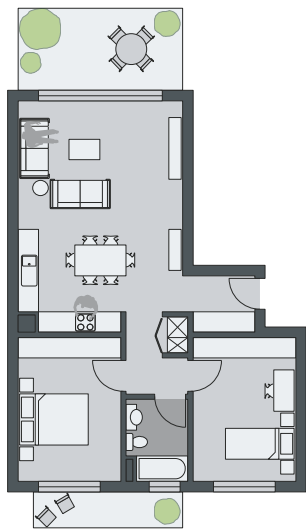

2 bedroom "L" dual aspect apartment

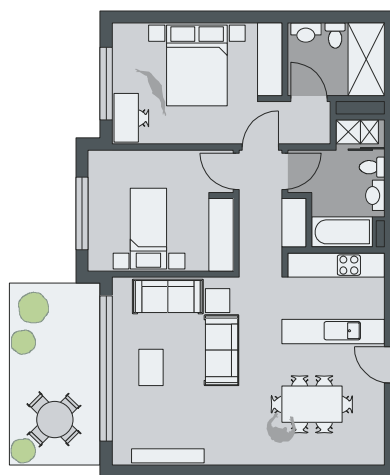

2 bedroom mid-floor plate single aspect

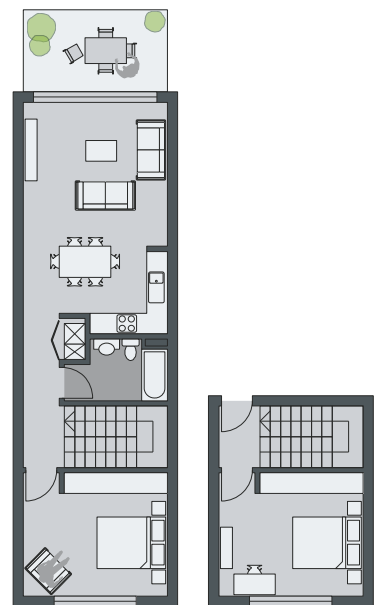

2 bedroom mid-floor plate cross-over

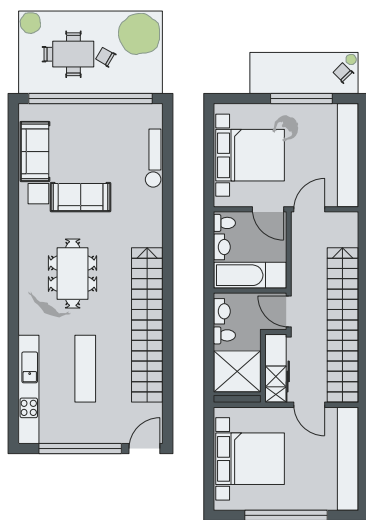

2 bedroom mid-floor plate 2 storey gallery access

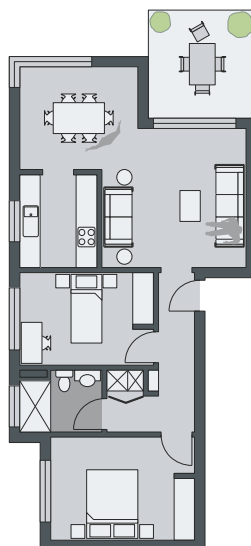

2 bedroom corner apartment

Figure 4D.5 Diagrams showing indicative layouts for 2 bedroom apartments
 Note: these do not represent the only solutions

Indicative layouts

3 bedroom

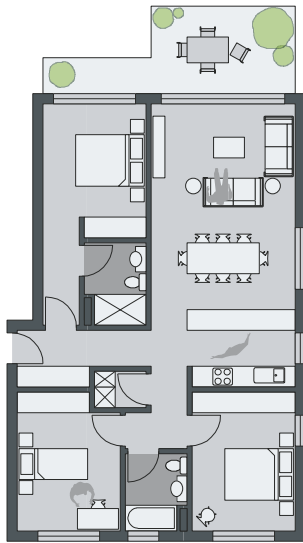

3 bedroom corner apartment

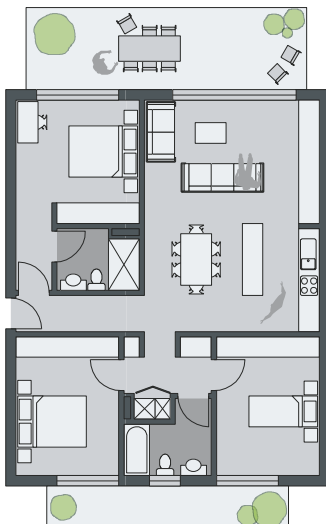

3 bedroom mid-floor plate cross-through apartment

Figure 4D.6 Diagrams showing indicative layouts for 3 bedroom apartments
Note: these do not represent the only solutions

Where possible:

- bathrooms and laundries should have an external openable window
- main living spaces should be oriented toward the primary outlook and aspect and away from noise sources

Objective 4D-3

Apartment layouts are designed to accommodate a variety of household activities and needs

Design criteria

1. Master bedrooms have a minimum area of 10m² and other bedrooms 9m² (excluding wardrobe space)
2. Bedrooms have a minimum dimension of 3m (excluding wardrobe space)
3. Living rooms or combined living/dining rooms have a minimum width of:
 - 3.6m for studio and 1 bedroom apartments
 - 4m for 2 and 3 bedroom apartments
4. The width of cross-over or cross-through apartments are at least 4m internally to avoid deep narrow apartment layouts

Design guidance

Access to bedrooms, bathrooms and laundries is separated from living areas minimising direct openings between living and service areas

All bedrooms allow a minimum length of 1.5m for robes

The main bedroom of an apartment or a studio apartment should be provided with a wardrobe of a minimum 1.8m long, 0.6m deep and 2.1m high

Apartment layouts allow flexibility over time, design solutions may include:

- dimensions that facilitate a variety of furniture arrangements and removal
- spaces for a range of activities and privacy levels between different spaces within the apartment
- dual master apartments
- dual key apartments

Note: dual key apartments which are separate but on the same title are regarded as two sole occupancy units for the purposes of the Building Code of Australia and for calculating the mix of apartments

- room sizes and proportions or open plans (rectangular spaces (2:3) are more easily furnished than square spaces (1:1))
- efficient planning of circulation by stairs, corridors and through rooms to maximise the amount of usable floor space in rooms

4E Private open space and balconies

Private open spaces are outdoor spaces of the apartment, including balconies, courtyards and terraces, which enhance the amenity and indoor/outdoor lifestyle of residents. They capitalise on New South Wales' temperate climate, providing an area for external activities and an extension of living spaces.

Balconies that are safe and appropriately designed can provide space for children to play outdoors, and the opportunity for pet ownership.

Private open spaces are also important architectural elements on the outside of an apartment building, contributing to the form and articulation of the building with fences, balustrades and screens.

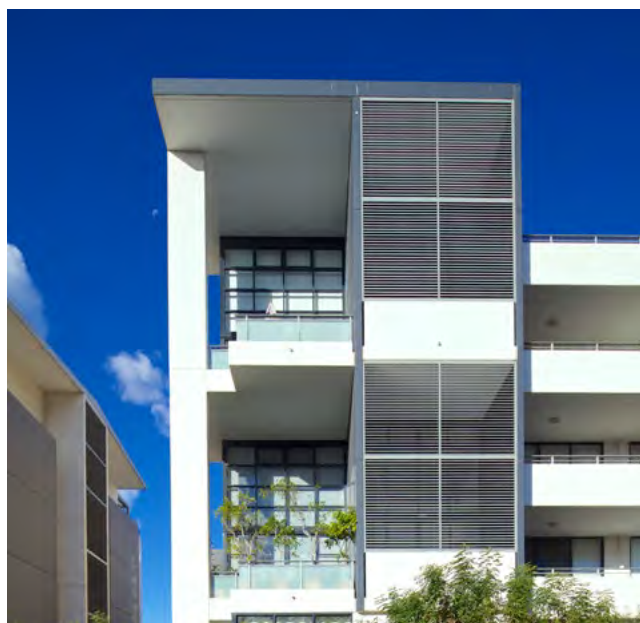

Figure 4E.1 Balconies, courtyards and terraces enhance the amenity and indoor/outdoor lifestyle of residents

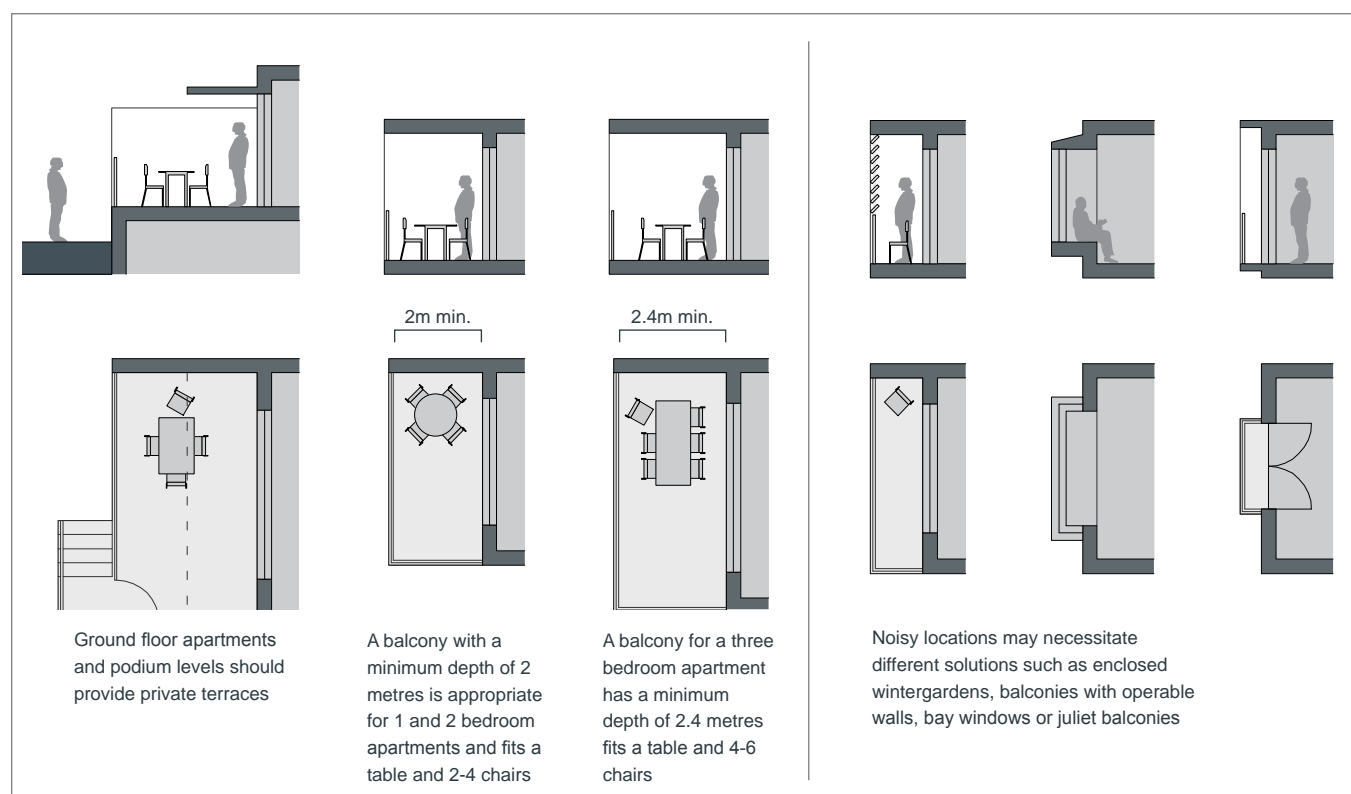

Figure 4E.2 Diagrams illustrating minimum balcony depth and options for noise treatment

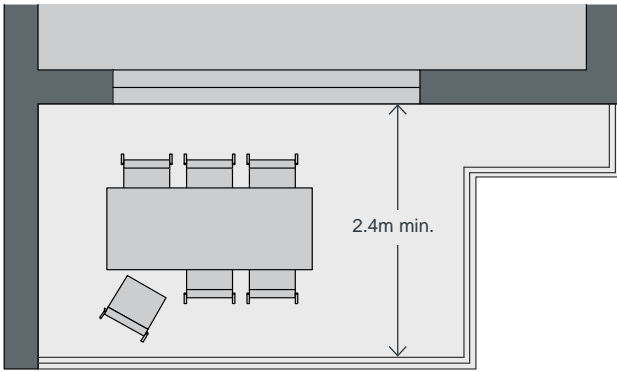

Figure 4E.3 Minimum balcony depths ensure that the balcony area is useable and can be easily accessed



Figure 4E.4 Building layout should maximise balcony use by allowing access from the main living area and a bedroom (where possible). Secondary balconies provide further amenity to apartment living and are best accessed off kitchens and laundries



Figure 4E.5 Primary balconies provide outdoor living, articulate the building facade and contribute to the safety of the public domain through increased surveillance opportunities

Objective 4E-1

Apartments provide appropriately sized private open space and balconies to enhance residential amenity

Design criteria

1. All apartments are required to have primary balconies as follows:

Dwelling type	Minimum area	Minimum depth
Studio apartments	4m ²	-
1 bedroom apartments	8m ²	2m
2 bedroom apartments	10m ²	2m
3+ bedroom apartments	12m ²	2.4m

The minimum balcony depth to be counted as contributing to the balcony area is 1m

2. For apartments at ground level or on a podium or similar structure, a private open space is provided instead of a balcony. It must have a minimum area of 15m² and a minimum depth of 3m

Design guidance

Increased communal open space should be provided where the number or size of balconies are reduced

Storage areas on balconies is additional to the minimum balcony size

Balcony use may be limited in some proposals by:

- consistently high wind speeds at 10 storeys and above
- close proximity to road, rail or other noise sources
- exposure to significant levels of aircraft noise
- heritage and adaptive reuse of existing buildings

In these situations, juliet balconies, operable walls, enclosed wintergardens or bay windows may be appropriate, and other amenity benefits for occupants should also be provided in the apartments or in the development or both. Natural ventilation also needs to be demonstrated

Objective 4E-2

Primary private open space and balconies are appropriately located to enhance liveability for residents

Design guidance

Primary open space and balconies should be located adjacent to the living room, dining room or kitchen to extend the living space

Private open spaces and balconies predominantly face north, east or west

Primary open space and balconies should be orientated with the longer side facing outwards or be open to the sky to optimise daylight access into adjacent rooms

4E Private open space and balconies



Figure 4E.6 For one and two bedroom apartments, balconies should be at least 2m deep to allow enough space for a small table



Figure 4E.7 Balconies should be designed to be safe outdoor spaces for children

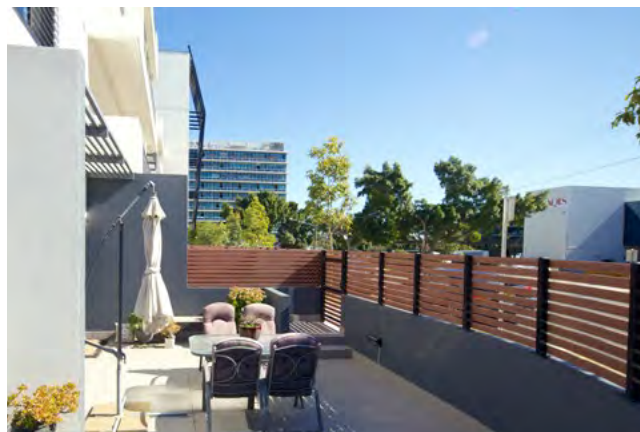

Figure 4E.8 Partially solid fences and balustrades allow views and passive surveillance of the street while maintaining visual privacy to ground level apartments

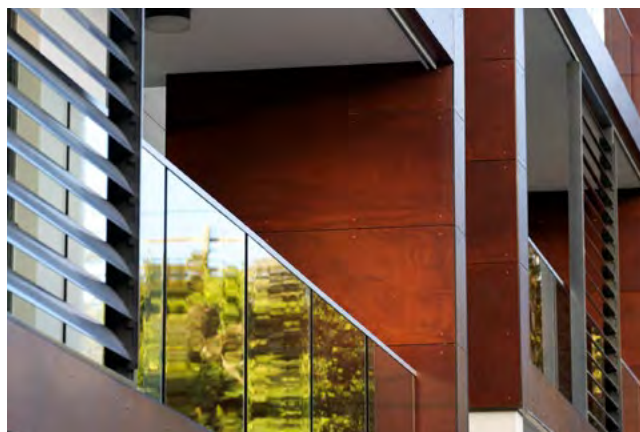

Figure 4E.9 A combination of solid and transparent materials balances the need for privacy with surveillance of the public domain



Figure 4E.10 Viewed from the inside, screening increases privacy and allows for storage and external clothes drying



Figure 4E.11 Setting the balustrade back from the building edge allows for landscaping towards the street for increased privacy

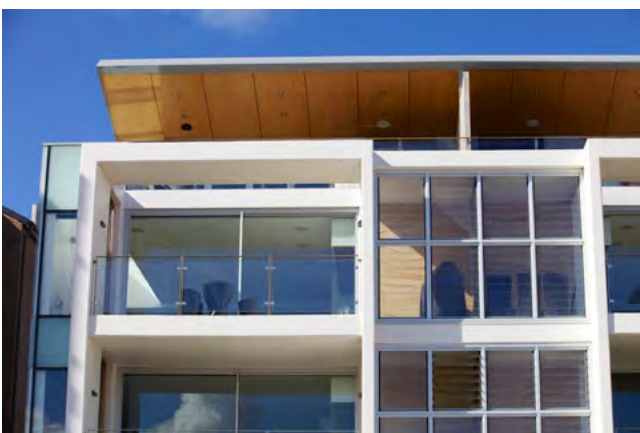

Figure 4E.12 Soffits and undersides of balconies should be well detailed as they are visible from the street

Objective 4E-3

Private open space and balcony design is integrated into and contributes to the overall architectural form and detail of the building

Design guidance

Solid, partially solid or transparent fences and balustrades are selected to respond to the location. They are designed to allow views and passive surveillance of the street while maintaining visual privacy and allowing for a range of uses on the balcony. Solid and partially solid balustrades are preferred

Full width full height glass balustrades alone are generally not desirable

Projecting balconies should be integrated into the building design and the design of soffits considered

Operable screens, shutters, hoods and pergolas are used to control sunlight and wind

Balustrades are set back from the building or balcony edge where overlooking or safety is an issue

Downpipes and balcony drainage are integrated with the overall facade and building design

Air-conditioning units should be located on roofs, in basements, or fully integrated into the building design

Where clothes drying, storage or air conditioning units are located on balconies, they should be screened and integrated in the building design

Ceilings of apartments below terraces should be insulated to avoid heat loss

Water and gas outlets should be provided for primary balconies and private open space

Objective 4E-4

Private open space and balcony design maximises safety

Design guidance

Changes in ground levels or landscaping are minimised

Design and detailing of balconies avoids opportunities for climbing and falls

4F Common circulation and spaces

Common circulation and spaces within a building are shared communally by residents. They include lobbies, internal corridors and external galleries, vertical circulation such as lifts and stairs, as well as community rooms and other spaces.

Common circulation spaces provide opportunities for casual social interaction among residents and can assist with social recognition. Important design considerations include safety, amenity and durability. In addition, the choice of common circulation types has a direct influence on the apartment types provided, building form, articulation and the building's relationship to the street.

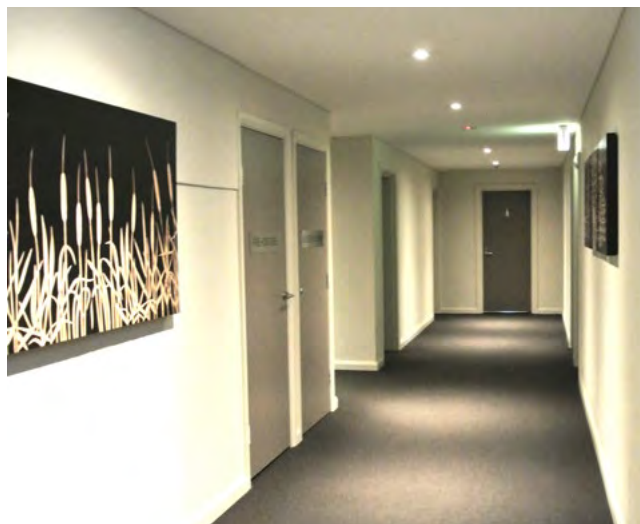

Figure 4F.1 The maximum number of apartments sharing a circulation core is eight



Figure 4F.2 The total number of apartments accessed off one circulation core should be eight or fewer

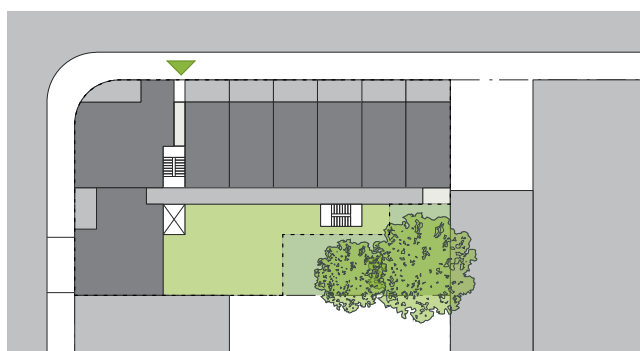

Figure 4F.3 External gallery access can be useful to maximise a desirable aspect for apartments or as a buffer to a noise source



Figure 4F.4 Multiple cores improve natural cross ventilation and provide more entries along the street, increasing activity and passive surveillance



Figure 4F.5 Mixed use buildings may have a range of circulation spaces including multiple cores, gallery access and double-loaded corridors with cross-over apartments



Figure 4F.6 Common areas should be provided in larger developments

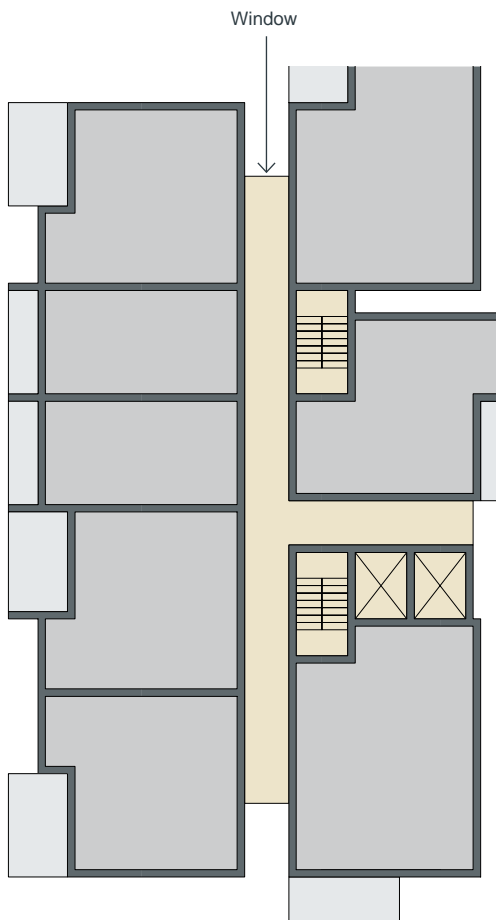

Figure 4F.7 Windows provide daylight and natural ventilation to common circulation spaces

Objective 4F-1

Common circulation spaces achieve good amenity and properly service the number of apartments

Design criteria

1. The maximum number of apartments off a circulation core on a single level is eight
2. For buildings of 10 storeys and over, the maximum number of apartments sharing a single lift is 40

Design guidance

Greater than minimum requirements for corridor widths and/or ceiling heights allow comfortable movement and access particularly in entry lobbies, outside lifts and at apartment entry doors

Daylight and natural ventilation should be provided to all common circulation spaces that are above ground

Windows should be provided in common circulation spaces and should be adjacent to the stair or lift core or at the ends of corridors

Longer corridors greater than 12m in length from the lift core should be articulated. Design solutions may include:

- a series of foyer areas with windows and spaces for seating
- wider areas at apartment entry doors and varied ceiling heights

Design common circulation spaces to maximise opportunities for dual aspect apartments, including multiple core apartment buildings and cross over apartments

Achieving the design criteria for the number of apartments off a circulation core may not be possible. Where a development is unable to achieve the design criteria, a high level of amenity for common lobbies, corridors and apartments should be demonstrated, including:

- sunlight and natural cross ventilation in apartments
- access to ample daylight and natural ventilation in common circulation spaces
- common areas for seating and gathering
- generous corridors with greater than minimum ceiling heights
- other innovative design solutions that provide high levels of amenity

Where design criteria 1 is not achieved, no more than 12 apartments should be provided off a circulation core on a single level

Primary living room or bedroom windows should not open directly onto common circulation spaces, whether open or enclosed. Visual and acoustic privacy from common circulation spaces to any other rooms should be carefully controlled

4F Common circulation and spaces



Photo: Michael Zanardo

Figure 4F.8 Incidental spaces can be used to provide seating opportunities for residents



Figure 4F.9 Natural daylight improves the amenity of common circulation areas and increases the likelihood of social interaction between residents



Photo: Michael Zanardo

Figure 4F.10 Common circulation spaces should provide short sight lines and be well lit at night



Figure 4F.11 Space for seating in common circulation spaces promotes opportunities for social interaction

Objective 4F-2

Common circulation spaces promote safety and provide for social interaction between residents

Design guidance

Direct and legible access should be provided between vertical circulation points and apartment entries by minimising corridor or gallery length to give short, straight, clear sight lines

Tight corners and spaces are avoided

Circulation spaces should be well lit at night

Legible signage should be provided for apartment numbers, common areas and general wayfinding

Incidental spaces, for example space for seating in a corridor, at a stair landing, or near a window are provided

In larger developments, community rooms for activities such as owners corporation meetings or resident use should be provided and are ideally co-located with communal open space

Where external galleries are provided, they are more open than closed above the balustrade along their length

4G Storage

Adequate storage is an important component of apartment design. It is calculated by volume as opposed to floor area and should be provided proportionally to the size of the apartment.

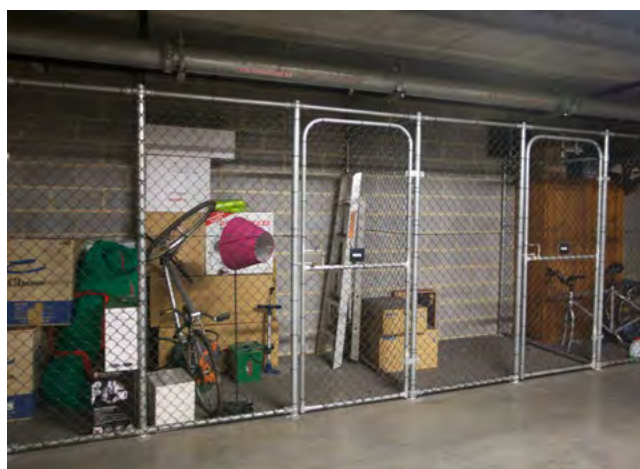
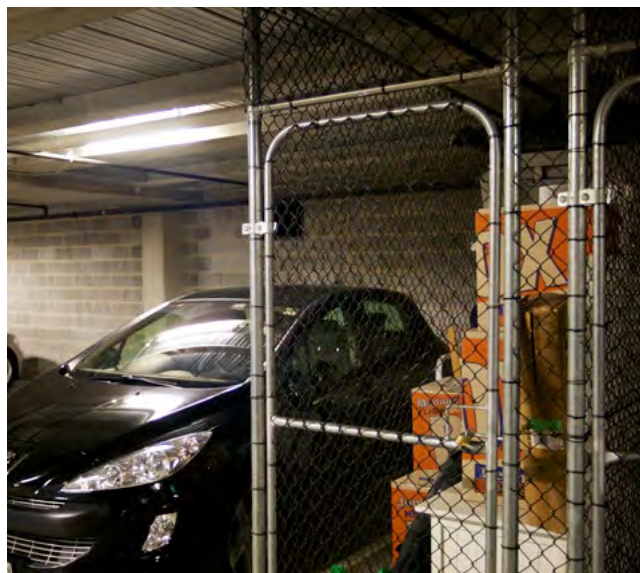

Figure 4G.1 Areas in car parks provide an opportunity to incorporate secure and convenient storage facilities for residents



Figure 4G.2 Storage within an apartment needs to be convenient and accessible from circulation or living areas



Figure 4G.3 Storage located on private balconies or within courtyards should be fully integrated and screened from view

Objective 4G-1

Adequate, well designed storage is provided in each apartment

Design criteria

1. In addition to storage in kitchens, bathrooms and bedrooms, the following storage is provided:

Dwelling type	Storage size volume
Studio apartments	4m ³
1 bedroom apartments	6m ³
2 bedroom apartments	8m ³
3+ bedroom apartments	10m ³

At least 50% of the required storage is to be located within the apartment

Design guidance

Storage is accessible from either circulation or living areas

Storage provided on balconies (in addition to the minimum balcony size) is integrated into the balcony design, weather proof and screened from view from the street

Left over space such as under stairs is used for storage

Objective 4G-2

Additional storage is conveniently located, accessible and nominated for individual apartments

Design guidance

Storage not located in apartments is secure and clearly allocated to specific apartments

Storage is provided for larger and less frequently accessed items

Storage space in internal or basement car parks is provided at the rear or side of car spaces or in cages so that allocated car parking remains accessible

If communal storage rooms are provided they should be accessible from common circulation areas of the building

Storage not located in an apartment is integrated into the overall building design and is not visible from the public domain

4H Acoustic privacy

Acoustic privacy is about protecting sound transmission between external and internal spaces, between apartments and communal areas and between apartments within a building.

Designing for acoustic privacy considers the site context, surrounding uses, building separation, the location of public and private open spaces and the arrangement of internal spaces in a building.

This section outlines typical considerations for acoustic privacy. For constrained sites such as sites near a rail corridor, major roads or underneath flight paths, refer to section 4J Noise and pollution for further guidance.



Figure 4H.1 Appropriate finishes, treatments and construction methods help reduce noise transmission through walls and floors

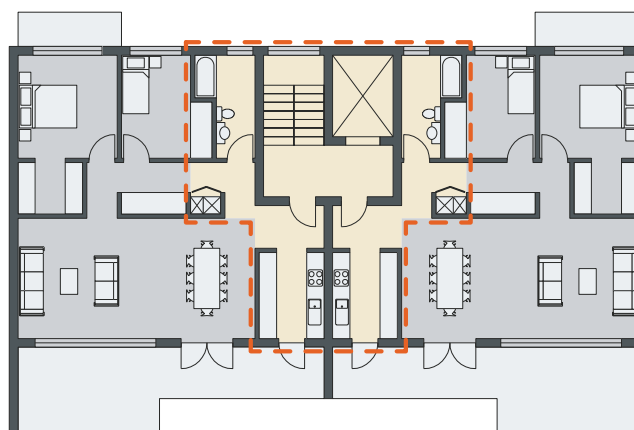

Figure 4H.2 The building layout should ensure that amenity impacts from noise are reduced to both living areas and bedrooms. The plan above locates living spaces away from the noisy access core



Figure 4H.3 The timing and extent of activities allowed in common areas should be considered and appropriately managed



Figure 4H.4 Bedrooms should be located at least 3m away from noise sources such as driveways and garage doors



Figure 4H.5 In addition to mindful siting and orientation of the building, acoustic seals and double or triple glazing are effective methods to further reduce noise transmission

Objective 4H-1

Noise transfer is minimised through the siting of buildings and building layout

Design guidance

Adequate building separation is provided within the development and from neighbouring buildings/adjacent uses (see also section 2F Building separation and section 3F Visual privacy)

Window and door openings are generally orientated away from noise sources

Noisy areas within buildings including building entries and corridors should be located next to or above each other and quieter areas next to or above quieter areas

Storage, circulation areas and non-habitable rooms should be located to buffer noise from external sources

The number of party walls (walls shared with other apartments) are limited and are appropriately insulated

Noise sources such as garage doors, driveways, service areas, plant rooms, building services, mechanical equipment, active communal open spaces and circulation areas should be located at least 3m away from bedrooms

Objective 4H-2

Noise impacts are mitigated within apartments through layout and acoustic treatments

Design guidance

Internal apartment layout separates noisy spaces from quiet spaces, using a number of the following design solutions:

- rooms with similar noise requirements are grouped together
- doors separate different use zones
- wardrobes in bedrooms are co-located to act as sound buffers

Where physical separation cannot be achieved noise conflicts are resolved using the following design solutions:

- double or acoustic glazing
- acoustic seals
- use of materials with low noise penetration properties
- continuous walls to ground level courtyards where they do not conflict with streetscape or other amenity requirements

4J Noise and pollution

Properties located near major roads, rail lines and beneath flight paths can be subject to noise and poor air quality. Similarly, hostile and noisy environments such as industrial areas, substations or sports stadiums can have impacts on residential amenity. Careful design solutions can help to improve quality of life in affected apartments by minimising potential noise and pollution impacts.

This section addresses design responses on sites that are affected by significant noise and pollution sources. Section 4H Acoustic privacy deals with more typical residential developments that do not face these challenges.

Development near rail corridors and busy roads

The NSW Government's *Development near Rail Corridors and Busy Roads - Interim Guideline* as called up by *State Environmental Planning Policy (Infrastructure) 2007* assists in the planning, design and assessment of development in, or adjacent to, rail corridors and busy roads. SEPP 65 development in these locations must have regard to this Guideline.



Figure 4J.1 Where balconies are oriented away from a noise source, changes in facade texture and detail along the busy road can assist in dispersing noise. This mixed use development is located on a busy road and is designed with limited openings exposed to the noise source

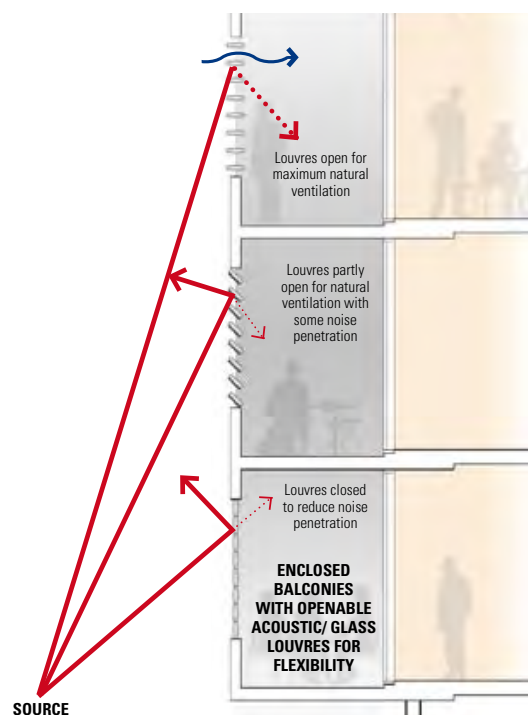

Figure 4J.2 Enclosing balconies to function as wintergardens is an effective means of reducing road and rail noise (Source: Development Near Rail Corridors And Busy Roads – Interim Guideline, NSW)

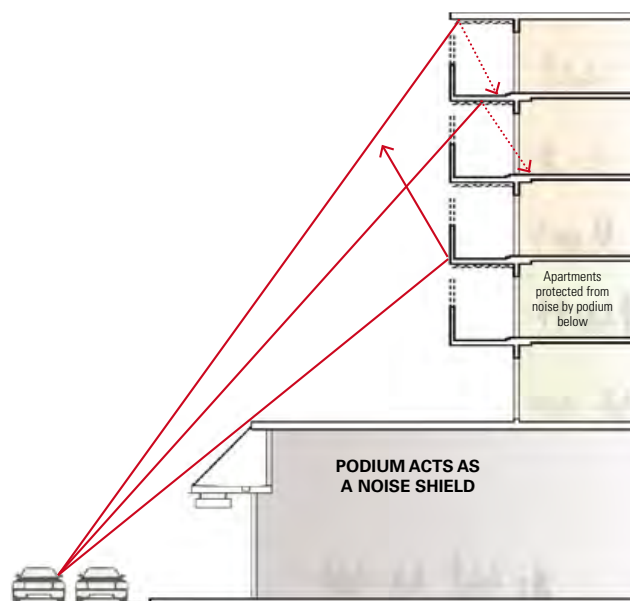

Figure 4J.3 Setting back the residential component above a podium helps shield apartments from major noise. Balcony soffits can be treated with sound absorption to assist to mitigate noise (Source: Development Near Rail Corridors And Busy Roads – Interim Guideline, NSW)

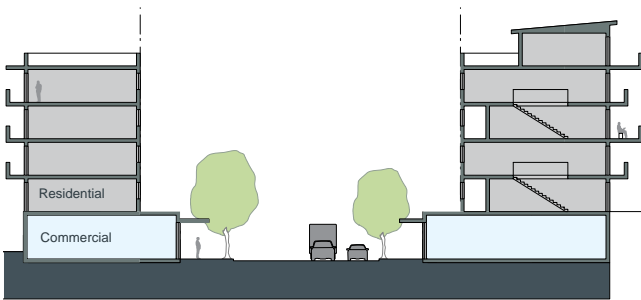

Figure 4J.4 Manage noise and pollution by providing non-residential uses at lower levels (vertical separation), setting-back residential uses (horizontal separation) and orienting private open space and windows that provide natural ventilation to habitable rooms away from the busy road or rail corridor

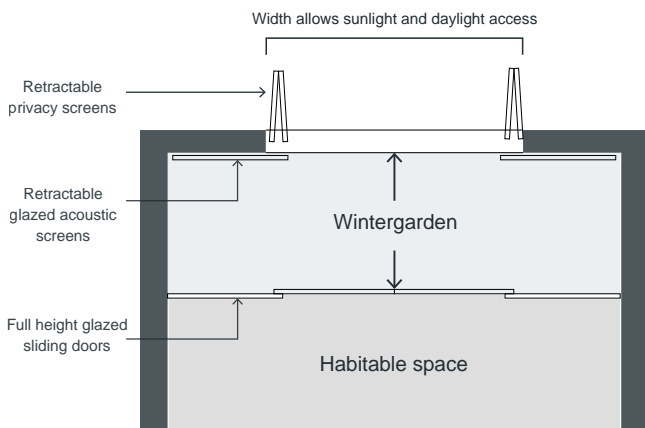

Figure 4J.5 Balconies designed as acoustically sealed wintergardens can improve liveability of the balcony and adjoining habitable rooms. In considering how much of the facade is solid or open, the width of the openings needs to be sufficient to allow sunlight and daylight access

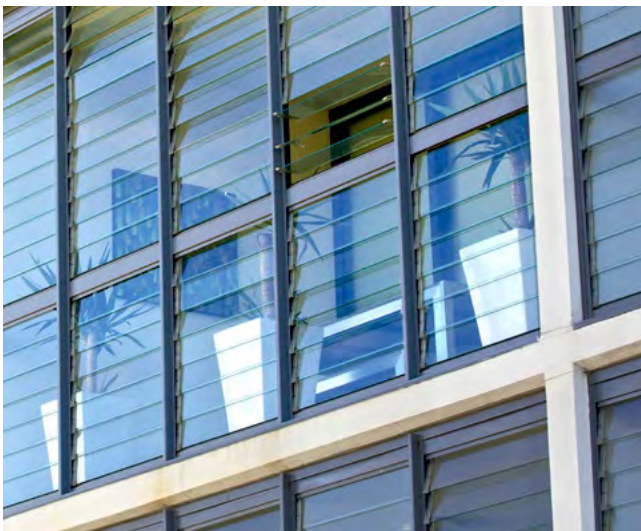

Figure 4J.6 Wintergardens can be either closed off or incorporated as living space, depending on the time of day and local conditions

Objective 4J-1

In noisy or hostile environments the impacts of external noise and pollution are minimised through the careful siting and layout of buildings

Design guidance

To minimise impacts the following design solutions may be used:

- physical separation between buildings and the noise or pollution source
- residential uses are located perpendicular to the noise source and where possible buffered by other uses
- non-residential buildings are sited to be parallel with the noise source to provide a continuous building that shields residential uses and communal open spaces
- non-residential uses are located at lower levels vertically separating the residential component from the noise or pollution source. Setbacks to the underside of residential floor levels should increase relative to traffic volumes and other noise sources
- buildings should respond to both solar access and noise. Where solar access is away from the noise source, non-habitable rooms can provide a buffer
- where solar access is in the same direction as the noise source, dual aspect apartments with shallow building depths are preferable (see figure 4J.4)
- landscape design reduces the perception of noise and acts as a filter for air pollution generated by traffic and industry

Achieving the design criteria in this Apartment Design Guide may not be possible in some situations due to noise and pollution. Where developments are unable to achieve the design criteria, alternatives may be considered in the following areas:

- solar and daylight access
- private open space and balconies
- natural cross ventilation

Objective 4J-2

Appropriate noise shielding or attenuation techniques for the building design, construction and choice of materials are used to mitigate noise transmission

Design guidance

Design solutions to mitigate noise include:

- limiting the number and size of openings facing noise sources
- providing seals to prevent noise transfer through gaps
- using double or acoustic glazing, acoustic louvres or enclosed balconies (wintergardens)
- using materials with mass and/or sound insulation or absorption properties e.g. solid balcony balustrades, external screens and soffits

4K Apartment mix

Apartment mix refers to the percentage of apartments with different numbers of bedrooms in a development. The number of bedrooms is directly related to floor area which in turn determines the yield that can be generated on the site.

A mix of apartment types provides housing choice and supports equitable housing access. By accommodating a range of household types, apartment buildings support the needs of the community now and into the future. This is particularly important because apartment buildings form a significant and often long term part of the urban fabric.



Figure 4K.1 The mix of apartments provided in a development should respond to the housing needs of the local area



Figure 4K.2 Apartment mix that is reflected in the facade composition adds variety and visual interest

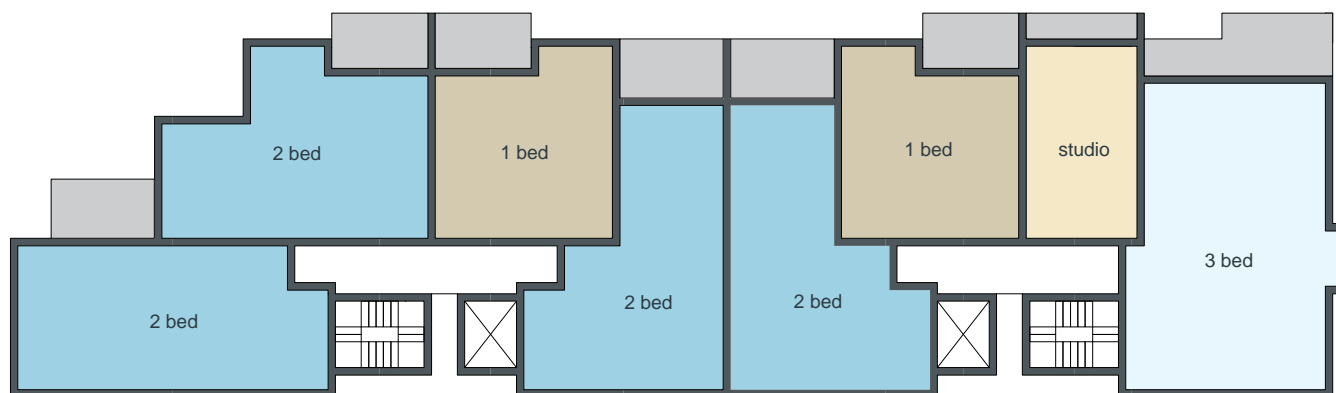

Figure 4K.3 A variety of apartments can be accommodated within a floor plate

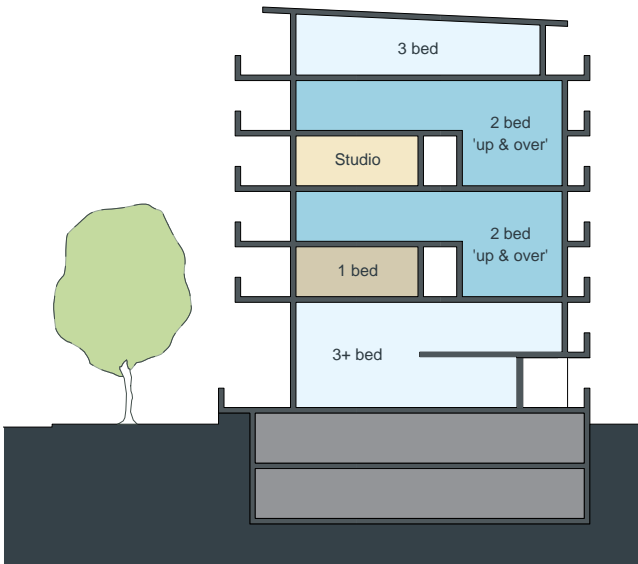

Figure 4K.4 Large apartments are often located on the ground or roof level due to opportunities for increased private open space. Internal common circulation (e.g. corridors) can be reduced by adding 'up and over' apartments to the mix



Figure 4K.5 Flexible apartment configurations should be provided to support diverse household types and stages of life

Objective 4K-1

A range of apartment types and sizes is provided to cater for different household types now and into the future

Design guidance

A variety of apartment types is provided

The apartment mix is appropriate, taking into consideration:

- the distance to public transport, employment and education centres
- the current market demands and projected future demographic trends
- the demand for social and affordable housing
- different cultural and socioeconomic groups

Flexible apartment configurations are provided to support diverse household types and stages of life including single person households, families, multi-generational families and group households

Objective 4K-2

The apartment mix is distributed to suitable locations within the building

Design guidance

Different apartment types are located to achieve successful facade composition and to optimise solar access (see figure 4K.3)

Larger apartment types are located on the ground or roof level where there is potential for more open space and on corners where more building frontage is available

4L Ground floor apartments

Ground floor apartments offer the potential for at-grade landscaped private open spaces and direct access from the street. They also provide opportunities for the apartment building and its landscape to respond to the human scale of the streetscape. On steep sites they may be located over different floors of the building stepping down the site.

Ground floor apartments can be of particular benefit to the elderly and disabled as they are generally more accessible. They also suit families with small children and extend the lifestyle choices available in apartment buildings by facilitating activities such as home business, gardening, outdoor play and pet ownership.

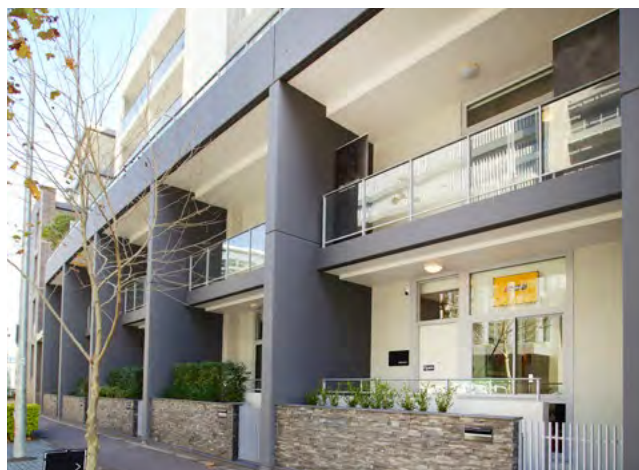

Figure 4L.2 The ground floor component of this double storey apartment is flexible and can be used as a home office



Figure 4L.1 Ground floor apartments should address the public domain and be accessed directly from the street

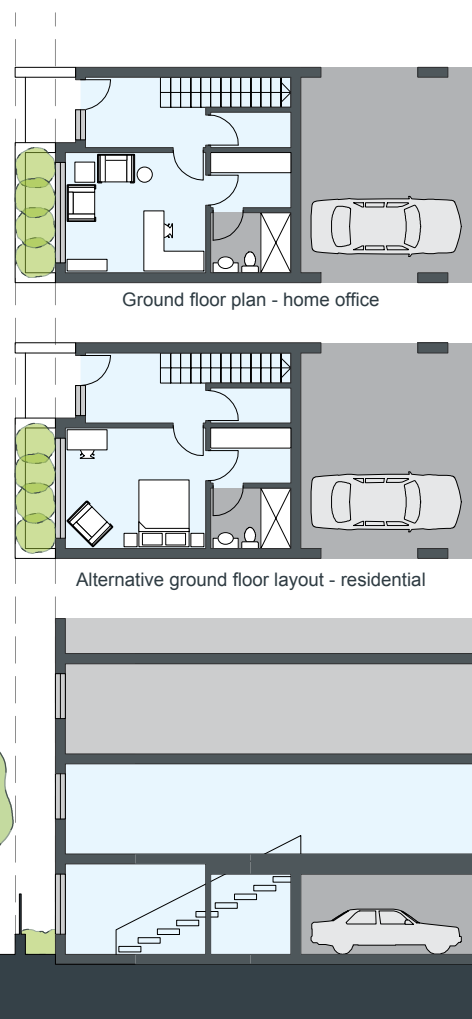

Figure 4L.3 Plan and section of a double storey apartment which is directly accessible from the street

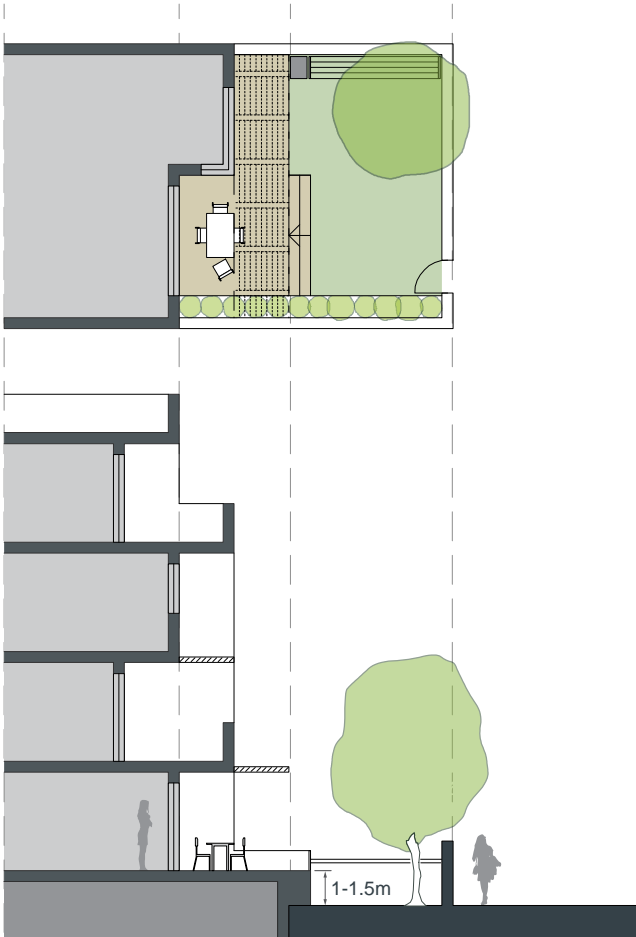

Figure 4L.4 Plan and section of a ground floor apartment with an elevated terrace and a level private courtyard

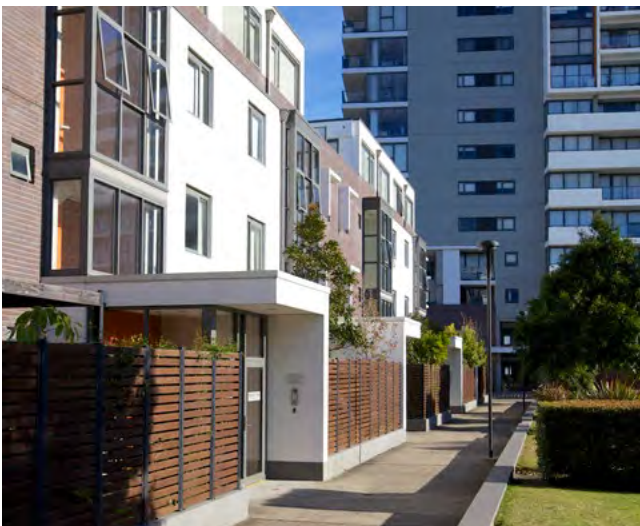

Figure 4L.5 The design of courtyards should balance the need for privacy of ground floor apartments with surveillance of public spaces

Objective 4L-1

Street frontage activity is maximised where ground floor apartments are located

Design guidance

Direct street access should be provided to ground floor apartments

Activity is achieved through front gardens, terraces and the facade of the building. Design solutions may include:

- both street, foyer and other common internal circulation entrances to ground floor apartments
- private open space is next to the street
- doors and windows face the street

Retail or home office spaces should be located along street frontages

Ground floor apartment layouts support small office home office (SOHO) use to provide future opportunities for conversion into commercial or retail areas. In these cases provide higher floor to ceiling heights and ground floor amenities for easy conversion

Objective 4L-2

Design of ground floor apartments delivers amenity and safety for residents

Design guidance

Privacy and safety should be provided without obstructing casual surveillance. Design solutions may include:

- elevation of private gardens and terraces above the street level by 1-1.5m (see figure 4L.4)
- landscaping and private courtyards
- window sill heights that minimise sight lines into apartments
- integrating balustrades, safety bars or screens with the exterior design

Solar access should be maximised through:

- high ceilings and tall windows
- trees and shrubs that allow solar access in winter and shade in summer

4M Facades

The design of facades contributes greatly to the visual interest of the building and the character of the local area. Facades that face the street have an impact on the public domain, while side and rear facades often influence the amenity of neighbouring buildings and communal and private open spaces.

High quality facades are a balanced composition of building elements, textures, materials and colour selections. Well designed facades also reflect the use, internal layout and structure of an apartment building.

The composition and detailing of a facade is not only important to the appearance of the building, it also influences its perceived scale. The pattern and repetitions of the facade, the proportions and articulation of external walls and the detailed design of facade elements are all important considerations.



Figure 4M.1 Thoughtful modulation of the facade reduces the perceived depth and bulk of a building



Figure 4M.2 Building facades should have an appropriate scale, rhythm and proportion relative to the streetscape



Figure 4M.3 Building articulation such as balconies and deeper window reveals provide visual interest to the facade



Figure 4M.4 The terracotta tile cladding used on this building contrasts with the white framed balconies and roof line, adding visual interest



Figure 4M.5 Changing facade materials, building articulation or height effectively highlights prominent corners

Objective 4M-1

Building facades provide visual interest along the street while respecting the character of the local area

Design guidance

Design solutions for front building facades may include:

- a composition of varied building elements
- a defined base, middle and top of buildings
- revealing and concealing certain elements
- changes in texture, material, detail and colour to modify the prominence of elements

Building services should be integrated within the overall facade

Building facades should be well resolved with an appropriate scale and proportion to the streetscape and human scale. Design solutions may include:

- well composed horizontal and vertical elements
- variation in floor heights to enhance the human scale
- elements that are proportional and arranged in patterns
- public artwork or treatments to exterior blank walls
- grouping of floors or elements such as balconies and windows on taller buildings

Building facades relate to key datum lines of adjacent buildings through upper level setbacks, parapets, cornices, awnings or colonnade heights

Shadow is created on the facade throughout the day with building articulation, balconies and deeper window reveals

Objective 4M-2

Building functions are expressed by the facade

Design guidance

Building entries should be clearly defined

Important corners are given visual prominence through a change in articulation, materials or colour, roof expression or changes in height

The apartment layout should be expressed externally through facade features such as party walls and floor slabs

4N Roof design

The roof is an important element in the overall composition and design of a building. Quality roof design provides a positive addition to the character of an area and can form an important part of the skyline. Roofs also provide opportunities for open space where appropriate and can add to the sustainability performance of a building.

The *Standard Instrument (Local Environmental Plans) Order 2006* allows for architectural roof features that can exceed the maximum building height. This is an important tool for achieving high quality roof design and articulation.



Figure 4N.1 Special roof features need to be proportionate to the overall building size, scale and form



Figure 4N.2 Architectural roof features and articulation are generally allowed to exceed the maximum statutory building height



Figure 4N.3 Solar access to apartments can be maximised by tilting roof elements towards the north



Figure 4N.4 The composition of this roof form creates a skyline silhouette and contributes to the identity and character of the area



Figure 4N.5 The composition and contemporary design of this roof top level adds visual interest

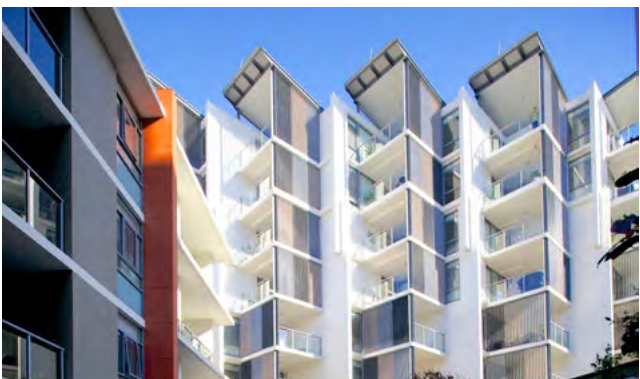

Figure 4N.6 This roof design creates an interesting view from street level, improves solar access and accentuates the built form rhythm

Objective 4N-1

Roof treatments are integrated into the building design and positively respond to the street

Design guidance

Roof design relates to the street. Design solutions may include:

- special roof features and strong corners
- use of skillion or very low pitch hipped roofs
- breaking down the massing of the roof by using smaller elements to avoid bulk
- using materials or a pitched form complementary to adjacent buildings

Roof treatments should be integrated with the building design. Design solutions may include:

- roof design proportionate to the overall building size, scale and form
- roof materials compliment the building
- service elements are integrated

Objective 4N-2

Opportunities to use roof space for residential accommodation and open space are maximised

Design guidance

Habitable roof space should be provided with good levels of amenity. Design solutions may include:

- penthouse apartments
- dormer or clerestory windows
- openable skylights

Open space is provided on roof tops subject to acceptable visual and acoustic privacy, comfort levels, safety and security considerations

Objective 4N-3

Roof design incorporates sustainability features

Design guidance

Roof design maximises solar access to apartments during winter and provides shade during summer. Design solutions may include:

- the roof lifts to the north
- eaves and overhangs shade walls and windows from summer sun

Skylights and ventilation systems should be integrated into the roof design

40 Landscape design

Successful landscape design complements the existing natural and cultural features of a site and contributes to the building's setting. Landscape design includes the planning, design, construction and maintenance of all external spaces.

Incorporating landscape design early in the design process provides optimal outcomes for residential apartments. It needs to be coordinated with other disciplines to ensure the building design and service locations complement the landscape and public domain.



Figure 40.2 Landscape design should include plants endemic to the region, enhancing biodiversity and providing habitat for native wildlife



Figure 40.1 Existing landscape features such as significant trees contribute to the overall quality of residential developments



Figure 40.3 Landscape design should respond to the local context by using complementary materials and planting schemes

Table 4 Recommended tree planting in deep soil zones

Site area	Recommended tree planting
Up to 850m ²	1 medium tree per 50m ² of deep soil zone
Between 850 - 1,500m ²	1 large tree or 2 medium trees per 90m ² of deep soil zone
Greater than 1,500m ²	1 large tree or 2 medium trees per 80m ² of deep soil zone



Figure 40.4 Shading trees improve the microclimate and are particularly effective along the eastern and western elevations of buildings

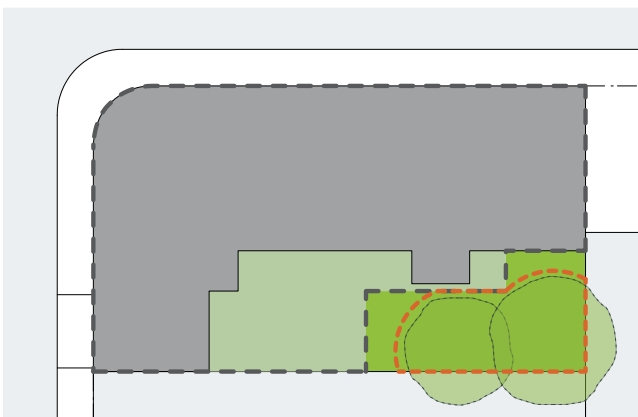

- tree protection zone
- construction zone

Figure 40.5 Where trees are retained, tree protection zones need to be established during construction to protect the canopy and roots

Objective 40-1

Landscape design is viable and sustainable

Design guidance

Landscape design should be environmentally sustainable and can enhance environmental performance by incorporating:

- diverse and appropriate planting
- bio-filtration gardens
- appropriately planted shading trees
- areas for residents to plant vegetables and herbs
- composting
- green roofs or walls

Ongoing maintenance plans should be prepared

Microclimate is enhanced by:

- appropriately scaled trees near the eastern and western elevations for shade
- a balance of evergreen and deciduous trees to provide shading in summer and sunlight access in winter
- shade structures such as pergolas for balconies and courtyards

Tree and shrub selection considers size at maturity and the potential for roots to compete (see Table 4)

Objective 40-2

Landscape design contributes to the streetscape and amenity

Design guidance

Landscape design responds to the existing site conditions including:

- changes of levels
- views
- significant landscape features including trees and rock outcrops

Significant landscape features should be protected by:

- tree protection zones (see figure 40.5)
- appropriate signage and fencing during construction

Plants selected should be endemic to the region and reflect the local ecology

4P Planting on structures

Planting on structures is where plants are on top of built structures such as basement car parks, podiums, roofs and walls. Planting on structures can provide amenity, improve air quality and microclimate, and reduce direct energy use and stormwater runoff. It can also supplement deep soil planting on sites where opportunities for this are limited or restricted, e.g. in high density areas.

Common ways of planting on structures include green roofs, green walls, raised planters and roof top gardens. Plants grown in these situations are subject to a range of environmental stressors that affect both the health and vigour of the plants. Designing soil profiles, irrigation and systems that provide adequate oxygen, water and nutrients is crucial for plant survival.



Figure 4P.1 Green walls and facades make positive contributions to the environment and to urban amenity more generally. They can also improve the sustainability performance of a building

Table 5 Minimum soil standards for plant types and sizes

Plant type	Definition	Soil volume	Soil depth	Soil area
Large trees	12-18m high, up to 16m crown spread at maturity	150m ³	1,200mm	10m x 10m or equivalent
Medium trees	8-12m high, up to 8m crown spread at maturity	35m ³	1,000mm	6m x 6m or equivalent
Small trees	6-8m high, up to 4m crown spread at maturity	9m ³	800mm	3.5m x 3.5m or equivalent
Shrubs			500-600mm	
Ground cover			300-450mm	
Turf			200mm	

Note: The above has been calculated assuming fortnightly irrigation. Any sub-surface drainage requirements are in addition to the above minimum soil depths



Figure 4P.2 Planting on structures are a way to create open space, in particular where opportunities for deep soil zones are restricted



Figure 4P.3 Roof top planting requires careful plant selection and an understanding of the local climate conditions



Figure 4P.4 Methods for planting on structures include raised planters and a mix of shallow and deep profile garden beds

Objective 4P-1

Appropriate soil profiles are provided

Design guidance

Structures are reinforced for additional saturated soil weight

Soil volume is appropriate for plant growth, considerations include:

- modifying depths and widths according to the planting mix and irrigation frequency
- free draining and long soil life span
- tree anchorage

Minimum soil standards for plant sizes should be provided in accordance with Table 5

Objective 4P-2

Plant growth is optimised with appropriate selection and maintenance

Design guidance

Plants are suited to site conditions, considerations include:

- drought and wind tolerance
- seasonal changes in solar access
- modified substrate depths for a diverse range of plants
- plant longevity

A landscape maintenance plan is prepared

Irrigation and drainage systems respond to:

- changing site conditions
- soil profile and the planting regime
- whether rainwater, stormwater or recycled grey water is used

Objective 4P-3

Planting on structures contributes to the quality and amenity of communal and public open spaces

Design guidance

Building design incorporates opportunities for planting on structures. Design solutions may include:

- green walls with specialised lighting for indoor green walls
- wall design that incorporates planting
- green roofs, particularly where roofs are visible from the public domain
- planter boxes

Note: structures designed to accommodate green walls should be integrated into the building facade and consider the ability of the facade to change over time

4Q Universal design

Universal design is an international design philosophy that enables people to continue living in the same home by ensuring that apartments are able to change with the needs of the occupants. Universally designed apartments are safer and easier to enter, move around and live in. They benefit all members of the community, from young families to older people, their visitors, as well as those with permanent or temporary disabilities.

Incorporating universal design principles in apartment design is a step towards producing a robust, flexible housing stock. It ensures that simple and practical design features are incorporated into new buildings that would be difficult and costly to retrofit at a later date.

Universal design is different to adaptable housing which is governed by *Australian Standard AS 4299-1995 Adaptable Housing* and is specifically designed to allow for the future adaptation of a dwelling to accommodate the occupant's needs.

In addition flexible apartment design is also desirable to allow buildings to accommodate a diverse range of lifestyle needs such as different household structures, live/work housing arrangements and future changes in use.



Figure 4Q.1 A universally designed apartment provides design features such as wider circulation spaces, reinforced bathroom walls and easy to reach and operate fixtures



Figure 4Q.2 Wide and barrier free entries and common circulation spaces help accessibility

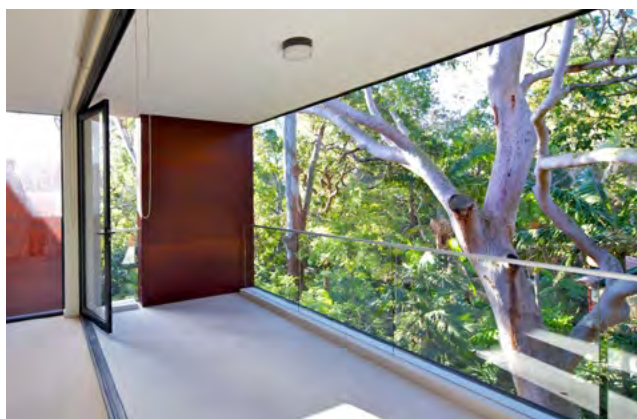

Figure 4Q.3 Level threshold transitions eliminate trip hazards

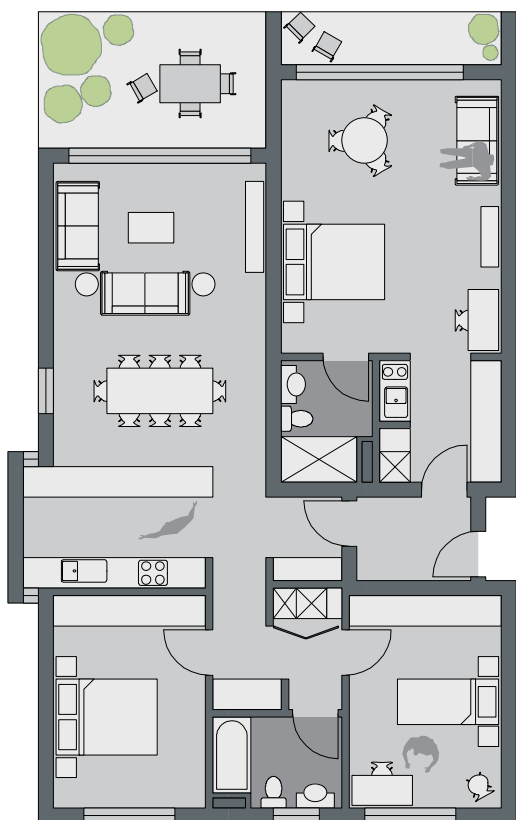

Figure 4Q.4 A flexible dual key apartment design allows for a variety of configurations including home office or separate tenancy
Note: dual key apartments which are separate but on the same title are regarded as two sole occupancy units for the purposes of the BCA and for calculating dwelling mix

Objective 4Q-1

Universal design features are included in apartment design to promote flexible housing for all community members

Design guidance

Developments achieve a benchmark of 20% of the total apartments incorporating the Livable Housing Guideline's silver level universal design features

Objective 4Q-2

A variety of apartments with adaptable designs are provided

Design guidance

Adaptable housing should be provided in accordance with the relevant council policy

Design solutions for adaptable apartments include:

- convenient access to communal and public areas
- high level of solar access
- minimal structural change and residential amenity loss when adapted
- larger car parking spaces for accessibility
- parking titled separately from apartments or shared car parking arrangements

Objective 4Q-3

Apartment layouts are flexible and accommodate a range of lifestyle needs

Design guidance

Apartment design incorporates flexible design solutions which may include:

- rooms with multiple functions
- dual master bedroom apartments with separate bathrooms
- larger apartments with various living space options
- open plan 'loft' style apartments with only a fixed kitchen, laundry and bathroom

4R Adaptive reuse

Buildings adapted for reuse as apartments can range from large houses, redundant industrial buildings, major institutional buildings and groups of buildings to commercial office towers.

There are many benefits of retaining existing buildings including sustainability, aesthetics, character and valuing their social and cultural significance. Adaptation of an existing building for a new residential use provides for its repurposing and should be approached in a way that acknowledges the past and respects its sense of place. The significance of heritage items or buildings in conservation areas needs to be respected. Modifications should ensure the building's continued relevance in the future. Residential adaptive reuse projects should be sensitively designed, to respect existing elements and character.

Non-residential buildings often have dimensions, layouts and orientations that are not designed for residential use. A balance must be achieved between the benefits of retaining existing buildings versus the quality of residential amenity that can be achieved.



Figure 4R.1 Modern materials can be used if their proportions and details suit the building and context, and allow for interpretation of old and new building elements



Figure 4R.2 Residential conversion of these silos successfully acknowledges the industrial past of this local landmark



Figure 4R.3 New building elements should be distinguishable from the original structure



Figure 4R.4 Contemporary infill can create an interesting dialogue between old and new, adding to the character of a place



Figure 4R.5 Places that demonstrate a connection to the past by reusing older structures often become popular destinations for people



Figure 4R.6 Adaptive reuse should respect the original building fabric and facade rhythm

Objective 4R-1

New additions to existing buildings are contemporary and complementary and enhance an area's identity and sense of place

Design guidance

Design solutions may include:

- new elements to align with the existing building
- additions that complement the existing character, siting, scale, proportion, pattern, form and detailing
- use of contemporary and complementary materials, finishes, textures and colours

Additions to heritage items should be clearly identifiable from the original building

New additions allow for the interpretation and future evolution of the building

Objective 4R-2

Adapted buildings provide residential amenity while not precluding future adaptive reuse

Design guidance

Design features should be incorporated sensitively into adapted buildings to make up for any physical limitations, to ensure residential amenity is achieved. Design solutions may include:

- generously sized voids in deeper buildings
- alternative apartment types when orientation is poor
- using additions to expand the existing building envelope

Some proposals that adapt existing buildings may not be able to achieve all of the design criteria in this Apartment Design Guide. Where developments are unable to achieve the design criteria, alternatives could be considered in the following areas:

- where there are existing higher ceilings, depths of habitable rooms could increase subject to demonstrating access to natural ventilation, cross ventilation (when applicable) and solar and daylight access (see also sections 4A Solar and daylight access and 4B Natural ventilation)
- alternatives to providing deep soil where less than the minimum requirement is currently available on the site
- building and visual separation – subject to demonstrating alternative design approaches to achieving privacy
- common circulation
- car parking
- alternative approaches to private open space and balconies

4S Mixed use

Mixed use development includes multiple uses in one building. In apartment buildings this is commonly achieved vertically with different uses stacked above one another. A vertical mix of uses is more likely to increase activity through the day and night which in turn improves passive surveillance of the public domain.

In areas zoned for mixed use development building design should allow for a range of non-residential uses. Where the location or site constraints are not suited for retail uses, the design should accommodate other uses such as commercial offices. Non-residential uses should be located on lower levels of buildings in areas where residential use may not be appropriate or desirable, such as along main roads or railway lines.

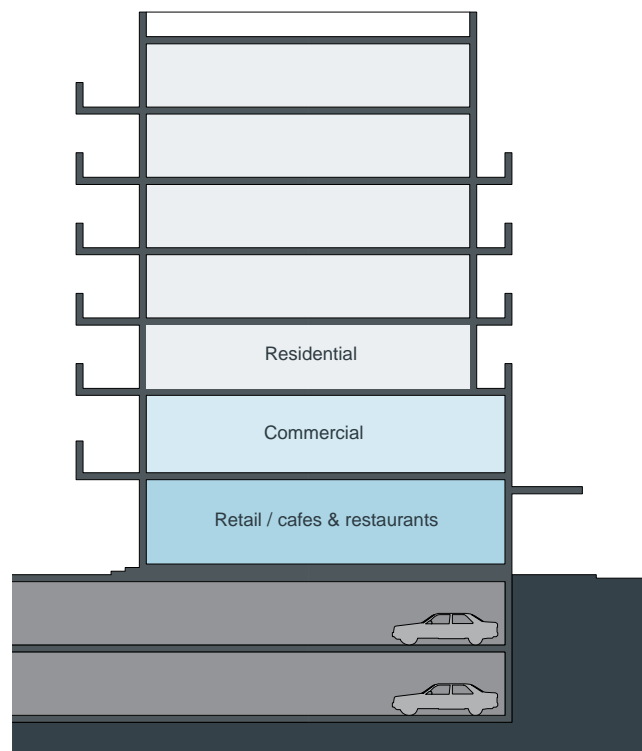

Figure 4S.2 Commercial floors are an appropriate buffer between residential apartments and busy active ground floor uses such as cafes



Figure 4S.1 A residential apartment building in a centre has retail uses at the ground floor level



Figure 4S.3 Shop and office entries, service areas and loading zones in a mixed use development should be separate from lobby entries to residential apartments



Figure 4S.4 A compact and varied mix of uses improves access to services and promotes walking, social interaction and safety



Figure 4S.5 Mixed use development should maximise retail and commercial activity at ground level

Objective 4S-1

Mixed use developments are provided in appropriate locations and provide active street frontages that encourage pedestrian movement

Design guidance

Mixed use development should be concentrated around public transport and centres

Mixed use developments positively contribute to the public domain. Design solutions may include:

- development addresses the street
- active frontages are provided
- diverse activities and uses
- avoiding blank walls at the ground level
- live/work apartments on the ground floor level, rather than commercial

Objective 4S-2

Residential levels of the building are integrated within the development, and safety and amenity is maximised for residents

Design guidance

Residential circulation areas should be clearly defined. Design solutions may include:

- residential entries are separated from commercial entries and directly accessible from the street
- commercial service areas are separated from residential components
- residential car parking and communal facilities are separated or secured
- security at entries and safe pedestrian routes are provided
- concealment opportunities are avoided

Landscaped communal open space should be provided at podium or roof levels

4T Awnings and signage

Awnings are prominent streetscape elements requiring considerable design attention. Continuous awnings encourage pedestrian activity along streets and in conjunction with active frontages, support and enhance the vitality of the local area. Together with building entries, awnings provide a public address, thereby contributing to the identity of a development.

Signage is also an important consideration in the design of apartment buildings located in mixed use areas, and should be integrated with the awning or street wall without obscuring or dominating important views.



Figure 4T.1 Continuous awnings should be provided where there is high pedestrian activity e.g. in centres and along active frontages



Figure 4T.2 Awnings should be designed as an integral element of the building and incorporate lighting for added safety

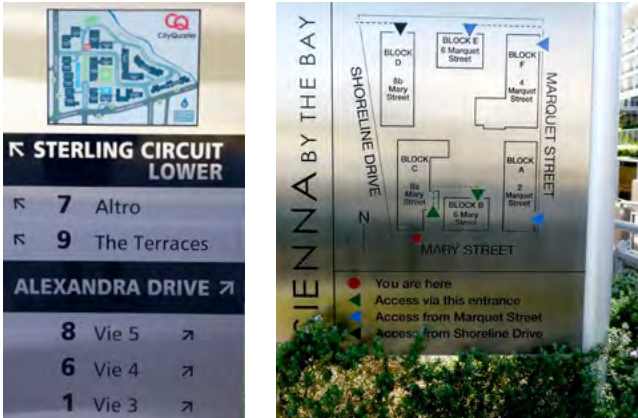

Figure 4T.3 Clear way-finding signage is important to both residents and visitors, in particular in larger residential developments



Figure 4T.4 Building address signage can be integrated as a feature of the facade design



Figure 4T.5 Signage should respond to the scale, proportion and detailing of the development and its surrounds

Objective 4T-1

Awnings are well located and complement and integrate with the building design

Design guidance

Awnings should be located along streets with high pedestrian activity and active frontages

A number of the following design solutions are used:

- continuous awnings are maintained and provided in areas with an existing pattern
- height, depth, material and form complements the existing street character
- protection from the sun and rain is provided
- awnings are wrapped around the secondary frontages of corner sites
- awnings are retractable in areas without an established pattern

Awnings should be located over building entries for building address and public domain amenity

Awnings relate to residential windows, balconies, street tree planting, power poles and street infrastructure

Gutters and down pipes should be integrated and concealed

Lighting under awnings should be provided for pedestrian safety

Objective 4T-2

Signage responds to the context and desired streetscape character

Design guidance

Signage should be integrated into the building design and respond to the scale, proportion and detailing of the development

Legible and discrete way finding should be provided for larger developments

Signage is limited to being on and below awnings and a single facade sign on the primary street frontage

4U Energy efficiency

Passive environmental and energy efficient design is about the ability of an apartment to manage thermal performance (thermal comfort) and daylight access, providing increased amenity to occupants and reducing energy costs.

This section offers guidance on meeting BASIX sustainability requirements and other rating systems through better design practice. For additional design practice linked to passive environmental design and energy efficiency see sections 4A Solar and daylight access, 4B Natural ventilation and 4D Apartment size and layout.



Figure 4U.1 Shading trees and landscaping contribute to the energy efficiency of buildings



Figure 4U.2 Example of shading devices that can be operated by the resident to manipulate the level of daylight and sun access

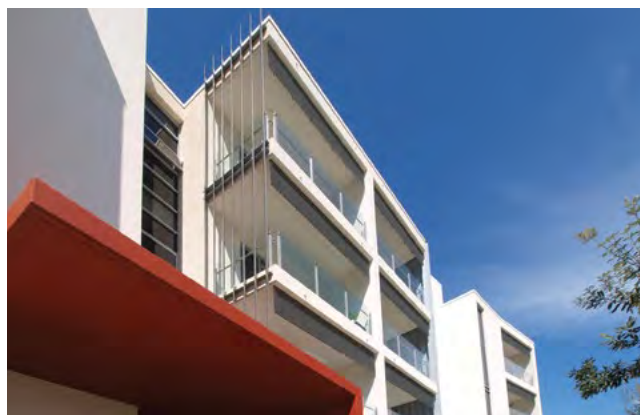

Figure 4U.3 Thermal mass in floors and walls allow for heat storage in winter and reduced heat transfer in summer

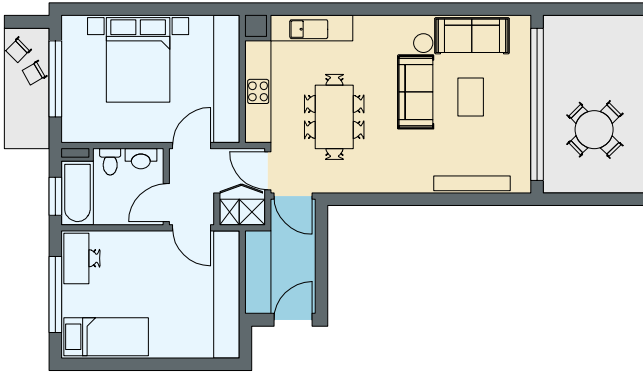

Figure 4U.4 Grouping rooms with similar uses together creates different zones in an apartment, helping to optimise energy use



Figure 4U.5 Environmental technology, integrated into the overall design, adds to the sustainable performance of buildings

Objective 4U-1

Development incorporates passive environmental design

Design guidance

Adequate natural light is provided to habitable rooms (see 4A Solar and daylight access)

Well located, screened outdoor areas should be provided for clothes drying

Objective 4U-2

Development incorporates passive solar design to optimise heat storage in winter and reduce heat transfer in summer

Design guidance

A number of the following design solutions are used:

- the use of smart glass or other technologies on north and west elevations
- thermal mass in the floors and walls of north facing rooms is maximised
- polished concrete floors, tiles or timber rather than carpet
- insulated roofs, walls and floors and seals on window and door openings
- overhangs and shading devices such as awnings, blinds and screens

Provision of consolidated heating and cooling infrastructure should be located in a centralised location (e.g. the basement)

Objective 4U-3

Adequate natural ventilation minimises the need for mechanical ventilation

Design guidance

A number of the following design solutions are used:

- rooms with similar usage are grouped together
- natural cross ventilation for apartments is optimised
- natural ventilation is provided to all habitable rooms and as many non-habitable rooms, common areas and circulation spaces as possible



Figure 4V.3 Water sensitive features are attractive elements able to effectively filter and reuse stormwater runoff

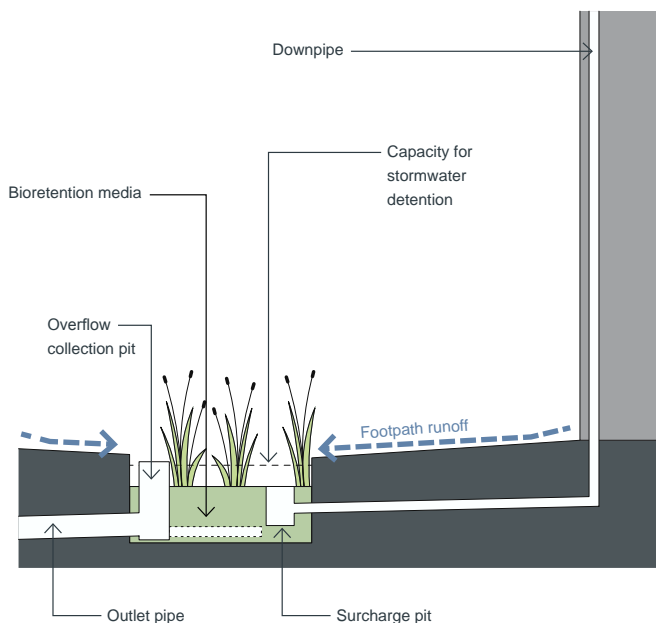

Figure 4V.4 A bioretention garden improves water quality by using plants to treat roof and surface water runoff

Objective 4V-1

Potable water use is minimised

Design guidance

Water efficient fittings, appliances and wastewater reuse should be incorporated

Apartments should be individually metered

Rainwater should be collected, stored and reused on site

Drought tolerant, low water use plants should be used within landscaped areas

Objective 4V-2

Urban stormwater is treated on site before being discharged to receiving waters

Design guidance

Water sensitive urban design systems are designed by a suitably qualified professional

A number of the following design solutions are used:

- runoff is collected from roofs and balconies in water tanks and plumbed into toilets, laundry and irrigation
- porous and open paving materials is maximised
- on site stormwater and infiltration, including bio-retention systems such as rain gardens or street tree pits

Objective 4V-3

Flood management systems are integrated into site design

Design guidance

Detention tanks should be located under paved areas, driveways or in basement car parks

On large sites parks or open spaces are designed to provide temporary on site detention basins

4W Waste management

The minimisation and effective management of domestic waste from apartments contributes to the visual and physical amenity of the building as well as limiting potentially harmful impacts on the environment.

Minimising waste is relevant to all stages of the building's life cycle and also includes safe and convenient collection and storage of waste and recycling. Waste management should be considered early on in the design process.



Figure 4W.1 Alternative waste disposal, such as composting, can be incorporated into the design of communal open space areas



Figure 4W.2 Common waste and recycling areas should be screened from view and well ventilated



Figure 4W.3 This residential development incorporates compost bins and a community garden for residents



Figure 4W.4 Well designed, easily accessible and clean waste and recycling rooms improve the collection and management of household waste

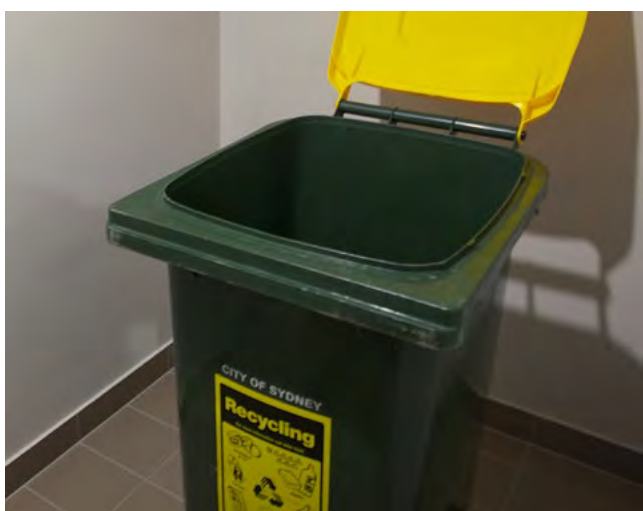

Figure 4W.5 Waste and recycling areas should allow for sufficient space to manoeuvre bins and sort waste for recycling

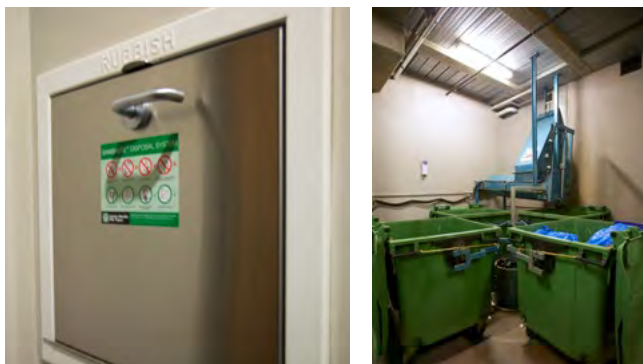

Figure 4W.6 For taller developments, garbage chutes can be located on floors to allow for convenient disposal of waste and recycling

Objective 4W-1

Waste storage facilities are designed to minimise impacts on the streetscape, building entry and amenity of residents

Design guidance

Adequately sized storage areas for rubbish bins should be located discreetly away from the front of the development or in the basement car park

Waste and recycling storage areas should be well ventilated

Circulation design allows bins to be easily manoeuvred between storage and collection points

Temporary storage should be provided for large bulk items such as mattresses

A waste management plan should be prepared

Objective 4W-2

Domestic waste is minimised by providing safe and convenient source separation and recycling

Design guidance

All dwellings should have a waste and recycling cupboard or temporary storage area of sufficient size to hold two days worth of waste and recycling

Communal waste and recycling rooms are in convenient and accessible locations related to each vertical core

For mixed use developments, residential waste and recycling storage areas and access should be separate and secure from other uses

Alternative waste disposal methods such as composting should be provided

4X Building maintenance

Careful design and material selection can reduce the long term maintenance obligations of apartment development. In addition, effective maintenance of the development ensures the longevity of buildings, sustaining the value of the property and reducing the life-cycle cost to owners.



Figure 4X.1 Building facades should use materials that are long lasting and weather well over time, such as brickwork, tiles and glass

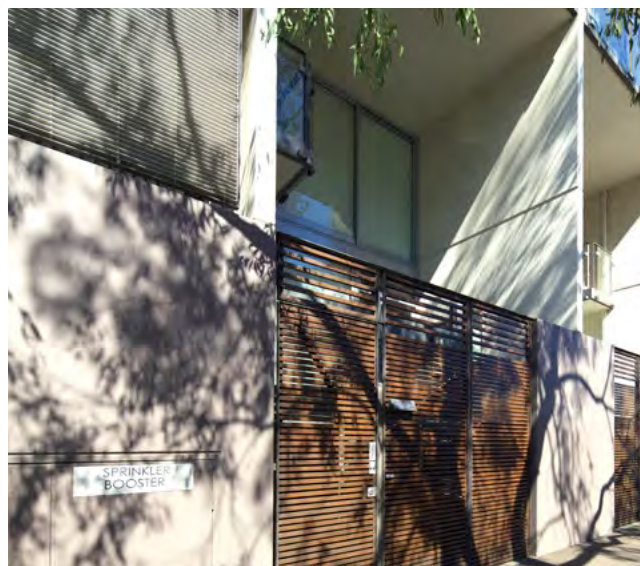

Figure 4X.2 The building layout should provide easy access for maintenance and inspection of services and plant equipment



Figure 4X.3 Roof overhangs, hoods and drip lines protect walls from the elements (rain, sun and wind) reducing maintenance costs

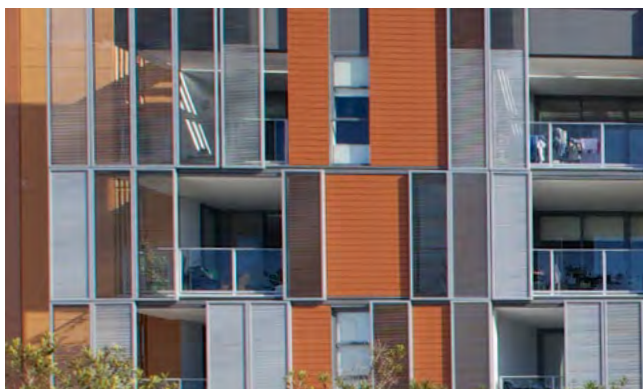

Figure 4X.4 Apartment windows should be designed so that they are easy to access and clean by residents

Objective 4X-1

Building design detail provides protection from weathering

Design guidance

A number of the following design solutions are used:

- roof overhangs to protect walls
- hoods over windows and doors to protect openings
- detailing horizontal edges with drip lines to avoid staining of surfaces
- methods to eliminate or reduce planter box leaching
- appropriate design and material selection for hostile locations

Objective 4X-2

Systems and access enable ease of maintenance

Design guidance

Window design enables cleaning from the inside of the building

Building maintenance systems should be incorporated and integrated into the design of the building form, roof and facade

Design solutions do not require external scaffolding for maintenance access

Manually operated systems such as blinds, sunshades and curtains are used in preference to mechanical systems

Centralised maintenance, services and storage should be provided for communal open space areas within the building

Objective 4X-3

Material selection reduces ongoing maintenance costs

Design guidance

A number of the following design solutions are used:

- sensors to control artificial lighting in common circulation and spaces
- natural materials that weather well and improve with time such as face brickwork
- easily cleaned surfaces that are graffiti resistant
- robust and durable materials and finishes are used in locations which receive heavy wear and tear, such as common circulation areas and lift interiors



A woman with dark hair tied back, wearing a grey blazer and a name tag, is seated at a long conference table. She is looking down at papers on the table. Other people are partially visible at the table, and there are papers, a water bottle, and a laptop. The background is a plain wall with a vertical seam.

Part 5

Design review panels

- 5A Function of design review panels
- 5B Membership and establishment
- 5C Roles and responsibilities
- 5D Meeting procedures
- 5E Templates

This part explains the role of design review panels in the development assessment process, outlines administrative procedures and provides templates for the successful operation of a panel. It is to be used by councils to administer design review panels at all relevant stages of the development process

5A Function of design review panels

SEPP 65 allows for design review panels to be established as an important tool to improve and enhance the design quality of apartment developments. Whether the panel is for one or more local government areas, they should operate consistently to provide certainty and efficiency.

This section of the Apartment Design Guide is a toolkit for the establishment and operation of design review panels. It includes details about:

- functions, membership and constitution
- roles and responsibilities of councils and panel members
- operating procedures and guidelines
- templates (meeting agenda, development assessment and meeting minutes).

General function

Design review panels are advisory only, and do not have a decision making function. Their primary functions are to:

- provide independent expert design advice on applications and policy for apartment buildings
- assist in improving the design quality of apartment development.

The panel advises on the design quality of applications with reference to SEPP 65's nine design quality principles and this Apartment Design Guide. The panel may identify and recommend improvements necessary to achieve consistency with the design quality principles and the Apartment Design Guide.

The advice has legal weight and can be relied upon by the consent authority when determining a development application or modification for apartment development under SEPP 65. It should be outlined in the planning officer's report to council. A full copy of the advice should be attached to the council report as well as being made publicly available on council's website.



Design review panels may also provide independent advice to consent authorities on design principles for local environmental plans, development control plans, precinct plans and other design related policies. This may include a review of design related controls, advice on methods to achieve design quality and local provisions related to apartment development. A council may seek advice from an established design review panel about other development applications that SEPP 65 does not apply to. In this case the design review panel's advice would be a matter for consideration for the consent authority and would be unrelated to SEPP 65.

Relationship between design review panels and architectural design competitions

A council is not required to send a development application for apartment development to a design review panel if an architectural design competition, consistent with the Director-General's Design Excellence Guidelines, has been held.

Pre-development application discussions

This Apartment Design Guide encourages pre-development application discussions, including early input by a design review panel. Early panel advice on a schematic proposal can allow applicants to address issues early on, and save time later in the application process.

5B Membership and establishment



Membership

A design review panel should consist of at least three members. However, it is recommended that two alternates also be appointed to ensure a quorum can be maintained. Panel members should have expertise in:

- architecture,
- landscape architecture, or
- urban design.

Councils should ensure that design review panels have a mix of expertise. Councillors, council officers or council employees cannot be appointed as panel members.

Panel establishment and selection of members

Councils should undertake the following steps to establish a design review panel under delegation, or to establish its own panel:

- resolve to establish a design review panel for the local government area/s
- seek expressions of interest for panel members from suitably qualified professionals
- assess the expressions of interest against the core selection criteria (see below) and any other additional criteria established to address local issues
- appoint members for a term of at least 2 years
- determine and confirm all terms of the appointment, including remuneration details for each member.

Core selection criteria for panel members

Expressions of Interest for design review panel members should include a brief professional profile addressing the selection criteria below:

Selection criteria	
1.	Appropriate qualification and demonstrated experience in the design of apartment developments in relation to architecture, landscape architecture or urban design
2.	Demonstrated highly developed skills and experience in urban analysis of local planning strategies and policies (e.g. local environmental plans, development control plans, precinct plans and town centre revitalisation) that contain provisions for apartment development
3.	Knowledge or understanding of local council policies and development controls
4.	Knowledge of the design issues of the local area
5.	Ability to analyse, evaluate and report on complex design quality issues for development applications and strategic planning
6.	Ability to develop design options and/or recommendations to ensure appropriate application of SEPP 65 design quality principles and the Apartment Design Guide
7.	Ability to work in a multi-disciplinary team
8.	Ability to liaise/negotiate with local government as well as the private sector
9.	Good written and verbal communication skills including the ability to translate technical information into plain English
10.	Knowledge, commitment and ability to implement council policies and standards, including those that relate to integrity, ethics, safety, anti-discrimination and equity

Funding and remuneration

Design review panel members are entitled to remuneration and the payment of expenses. The *Environmental Planning and Assessment Regulation 2000* allows councils with a design review panel to charge a maximum fee for the design review panel as part of development application fees. Councils are therefore responsible for the funding and remuneration of design review panels.

The following should be considered when determining funding and remuneration arrangements with design review panel members:

- where more than one council is involved in the operation of a design review panel, councils should fund the panel's operation on an equitable basis, for example, based on the number of development applications referred to the panel by each council
- the *Environmental Planning and Assessment Regulation 2000* allows a maximum additional development application fee to be charged for residential apartment development applications that will be referred to a design review panel. This allows councils to determine within their own fee policy how much they will charge up to the maximum amount. This may be influenced by the average design review panel costs per application and the estimated number of times an application will be referred to a design review panel
- councils are to remunerate each panel member commensurate with their professional role and meeting input. Remuneration should be fair and equitable taking into consideration the time taken to participate in design review panel processes.

5C Roles and responsibilities



Panel coordinator

Councils are responsible for coordinating the operation of the design review panel. It is suggested that a specific council officer be the nominated coordinator or the role may be shared amongst several officers. In the case of design review panels formed for more than one local government area, the role could be shared on a rotational basis.

Whichever approach is taken, arrangements about how tasks will be undertaken need to be established, particularly where more than one coordinator or council is involved.

The nominated coordinator will need to:

- determine the annual meeting schedule and make it publicly available
- be the central point of contact between the design review panel members and other council staff or stakeholders
- arrange meeting venues which have appropriate display space and room for applicants and other observers
- prepare and distribute meeting invites, application information and agendas, ensuring sufficient notice is provided to all parties
- arrange site inspections
- ensure in advance of each meeting that there will be a quorum
- arrange for relevant council staff members to attend meetings
- arrange minute taking and panel member endorsement of minutes
- distribute minutes to relevant parties and make them publicly available on council's website within 14 days of the panel meeting
- administer fee and member remuneration payments
- arrange for a summary of council decisions on applications considered by the panel to be given to panel members, providing feedback on consideration of applications and awareness of any other relevant matters
- provide information about the design review panel and its operation to any interested party, including new panel members.

Panel chairperson

The panel chair is responsible for:

- running design review meetings
- ensuring that the meeting agenda is followed and that allocated timeframes are adhered to
- ensuring that discussion remains focused on the application or matter being considered and that advice relates to matters covered by SEPP 65 and the Apartment Design Guide
- ensuring the advice and recommendations developed for each application is voted on by the panel. In the case of a tied vote, the chairperson has the casting vote
- ensuring the panel endorses the minutes
- liaising with council staff about the operation of the panel, where required
- attending meetings to brief councillors on panel advice, where required
- ensuring new members have been inducted and are briefed about panel operation.

Panel members

Panel members are required to:

- treat all discussions and information about applications with sensitivity and confidentiality
- provide independent, fair and reasonable professional advice relative to the design quality principles of SEPP 65 and this Apartment Design Guide
- respond to and comment on material presented, providing constructive feedback to make amendments as required.

Pecuniary interests

Under SEPP 65 design review panel members must disclose any pecuniary interests. Where a pecuniary interest exists, the member must:

- disclose the interest to the chair as soon as practicable, and preferably before the meeting to ensure there is a quorum for all items
- not take part in the consideration or discussion of the matter
- not vote on any advice or recommendations relating to the matter.

Pecuniary interests should be recorded in panel meeting minutes.

Agenda

The agenda is to be prepared and distributed, taking account of the following:

- applications should be referred to the design review panel as soon as possible after lodgement. This will ensure that design modifications can be identified early, together with any additional information being requested by council
- the agenda for each meeting should be circulated to all panel members and meeting attendees at least one week prior to the meeting. A meeting agenda template is included in section 5E Templates
- the priority of agenda items for each meeting should be determined by each council ensuring the timing has regard for their statutory timeframes
- each item should be allocated an equitable time slot on the agenda adjusted for complexity where appropriate, to allow fair and reasonable consideration of the application and time for a brief presentation by the applicant or their representative, as well as questions of them by the panel
- each agenda item should be accompanied by a brief development assessment overview prepared by council's assessment staff, giving a summary of the development's compliance with the key SEPP 65 requirements and council development standards.

5D Meeting procedures

The following design review panel meeting procedures have been developed to ensure consistency in the process and to make expectations clear for all parties. A council may choose to include additional operating procedures to address local circumstances. If a council chooses to include additional operating procedures the panel chair should make recommendations to the council for their endorsement.

It is recommended that an inception meeting be held when new design review panels are established to confirm general operating and meeting procedures. The inception meeting should be hosted by the council so that members can be briefed on specific operational matters. Meeting procedures can also be discussed and confirmed.

Suggested topics to be covered in the inception meeting are outlined below. Where individual new members are appointed to a panel at a later time, it is recommended that they be briefed jointly by the panel coordinator and chair on this information.

Suggested inception meeting topics:

- introduce panel coordinator, members, relevant council staff and provide contact details
- provide background on local planning and design issues and copies of relevant policies including the LEP and DCP
- advise of annual meeting schedule, confirm member responsibilities and reporting timeframes
- advise of responsibilities for preparing the agenda, circulation of project information and minutes
- confirm contact details for remuneration matters, and frequency of invoicing
- advise of council's media protocols
- determine a protocol for the panel responding to any media enquiries (e.g. only through the chair, or only through council's media unit)
- appoint a chairperson (which may be revolving)
- confirm standard meeting procedures and any additional local procedures
- arrange to advise the Minister for Planning and council of the agreed procedures and publicise on council's website.

Meeting preparation and site inspection

Panel members should familiarise themselves with the agenda and documents prior to the meeting.

Panel members should visit each site on the agenda prior to the meeting. Joint inspections are arranged by the panel coordinator, and can be part of the overall agenda for the day. Specific arrangements for this can be determined by each panel.

Quorum and attendance

Each meeting is to maintain a quorum. A quorum consists of three appointed or alternate design review panel members. If less than three members are present there is no quorum and the meeting cannot proceed. Panel members should attend at least 75% of design review panel meetings. The Minister or council/s may replace panel members who are regularly unavailable for meetings during a 12 month period.



Meeting format

The chairperson should run the meeting in accordance with the agenda. A suggested format for individual items includes:

- site inspections
- panel pre-discussion and application overview by council planning staff including site history, background, surrounding proposed/approved developments, compliance with planning controls, internal referral comments (e.g. heritage, stormwater, traffic/parking) and submissions/objections. Relevant state government agency comments should also be provided. Depending on the issue, a representative of the referral agency may also be invited to attend the meeting
- proponent presentation – short presentation explaining the project within the local context, background and how it addresses key design quality principles of SEPP 65 and the Apartment Design Guide
- panel questions/clarifications of the proponent – as required
- panel discussion – debate and drafting of advice and recommendations
- confirm agreed advice and recommendations – the chair convenes a vote by panel members on the advice and recommendations.

Where an application has been considered previously a site inspection may not be necessary and the council planning staff briefing will update the design review panel about the compliance of the amended scheme.

Providing advice and voting on recommendations

Panel members should be aware of the following points when providing advice and finalising recommendations:

- advice should be in plain English that is readily understood by the consent authority, the development proponent and the community
- advice should be consistent between scheme iterations. If significant changes are recommended that depart from previously issued advice they must be supported by full written justification
- when preparing advice, the panel should be aware that *State Environmental Planning Policy (Building Sustainability Index: BASIX) 2004* overrides SEPP 65 provisions on thermal performance, greenhouse emission reduction and water reduction
- either the design review panel or the council may require that additional expert assistance be sought in the assessment of a particular proposal or other matter
- panel members should vote on the recommendations for each proposal being considered. In the case of a tied vote, the chairperson has the casting vote.

Minutes and reporting

Panel members should be aware of the following points when minutes are being drafted:

- minutes should be recorded directly into the template and preferably wall-projected in the meeting room to enable recommendations to be finalised at the meeting. A meeting minutes template is provided in section 5E Templates
- the panel meeting minutes should include an accurate record of the key discussion points and panel recommendations
- the minutes are to be endorsed by the design review panel and returned to council within 14 days of the meeting. Ideally the minutes should be completed on the day of the meeting to streamline timeframes
- report recommendations should assist council's decision making, including suggested amendments, draft conditions of approval and if relevant, options for consideration.

SEPP 65 requires that the panel's advice be made publicly available and accessible. It should therefore be published on the council's website within seven days of receipt from the panel.

5E Templates

This section provides a number of standard templates to assist design review panels to operate in a consistent manner across NSW.

(a) Meeting Agenda Template

[LGA Name] Design Review Panel Meeting	
Agenda	
Meeting date:	
Time and location:	
Item No.	Subject
1	Attendance & apologies
2	Deferred applications
2.1	
2.2	
3.	New applications
3.1	
3.2	
4.	Other business / advice
5.	Next meeting – time / date
6.	Confirmation of minutes
7.	Meeting close
[Attendees council, panel, applicant, other]	

(b) Development Assessment Overview Template

This overview is to be prepared by the responsible council officer and distributed to the design review panel members with the meeting agenda at least one week before the meeting.

Development assessment overview

Proposed development	
Street address	
Applicant/owner	
Report by	
The proposal	[Brief and succinct summary of proposal]
Background	[A summary of relevant background information establishing history of the proposal to date including response to context and site; photos may also be useful]

Assessment summary

Council's key development standards		
	Proposed	Assessment
Floor space ratio		
Height		
Front setback		
Side setbacks		
Rear setback		
Other (e.g. building depths or envelopes)		
SEPP 65 key standards		
	Proposed	Assessment
3F Visual privacy		
3J Bicycle and car parking		
4A Solar and daylight access		
4F Common circulation and spaces		
4D Apartment size and layout		
4C Ceiling heights		
4E Private open space and balconies		
4B Natural ventilation		
4G Storage		
Key issues	[Summary / dot points]	

(c) Meeting Minutes Template

The Report of the design review panel is taken to also be the minutes of the review meeting. The report accurately records the discussion and recommendations reached at the review meeting. In endorsing the design review panel report, the design review panel has ensured the meeting discussion and the drafting of the report contain consistent conclusions and recommendations.

Meeting minutes and recommendations	
Time & date	
Meeting location	
Panel members	(Chair)
	(Member)
	(Member)
	(Member)
Apologies	
Council staff	
Guests	
Declarations of interest	
Business item and meeting minutes	
Item number	
DA number	
Property address	
Proposal	[Succinct summary of proposal]
Applicant or applicant's representative address to the design review panel	[Note if applicant addressed the design review panel. Include name and position]
Background	The site was inspected by the panel [DATE]
Key issues and recommendation	[Summary of key issues discussed] A development application was previously before the panel at its meeting of [DATE]. At this time the panel made the following recommendation: [Insert recommendation]

(d) Design Quality Test Template

The design review panel must establish if the proposal exhibits design quality or not, using the SEPP Design Quality Principles and the Apartment Design Guide. Suggested solutions should also be recorded in the amendments section for clarity.

Design Quality Test	
Nine design quality principles	Apartment Design Guide
	<i>This section must discuss all the relevant aspects of the Apartment Design Guide. Where design criteria is included, this must be discussed</i>
Principle 1 - Context and Neighbourhood Character	
[Record of discussion]	[Discussion of related section(s) of the Apartment Design Guide]
Principle 2 - Built Form and Scale	
Principle 3 - Density	
Principle 4 - Sustainability	
Principle 5 - Landscape	
Principle 6 - Amenity	
Principle 7 - Safety	
Principle 8 - Housing Diversity and Social Interaction	
Principle 9 - Aesthetics	
Amendments	[Identify any recommended amendments necessary to achieve design quality and the related design quality principle]
Recommendation	[Insert recommendation]





Appendices

- 1 Site analysis checklist
- 2 Pre-development application checklist
- 3 DA documentation checklist
- 4 Apartment building example schemes
- 5 Sunlight access analysis tool

Glossary

This part includes checklists for information required at different stages in the planning process

APPENDIX 1

Site analysis checklist

Documentation	Required information	Provided	
		Yes (✓)	No (x)
Site location	Broad map or aerial photo showing site location in relation to surrounding centres, shops, civic/community facilities and transport		
Aerial photograph	Colour aerial photographs of site in its context		
Local context plan	Plan(s) of the existing features of the wider context including adjoining properties and the other side of the street, that show:		
	<ul style="list-style-type: none"> • pattern of buildings, proposed building envelopes, setbacks and subdivision pattern 		
	<ul style="list-style-type: none"> • land use and building typologies of adjacent and opposite buildings in the street 		
	<ul style="list-style-type: none"> • movement and access for vehicles, servicing, pedestrians and cyclists 		
	<ul style="list-style-type: none"> • topography, landscape, open spaces and vegetation 		
	<ul style="list-style-type: none"> • significant views to and from the site 		
Site context and survey plan	Plan(s) of the existing site based on a survey drawing showing the features of the immediate site including:		
	<ul style="list-style-type: none"> • boundaries, site dimensions, site area, north point 		
	<ul style="list-style-type: none"> • topography, showing relative levels and contours at 0.5 metre intervals for the site and across site boundaries where level changes exist, any unique natural features such as rock outcrops, watercourses, existing cut or fill, adjacent streets and sites 		
	<ul style="list-style-type: none"> • location and size of major trees on site and relative levels where relevant, on adjacent properties and street trees 		
	<ul style="list-style-type: none"> • location and use of existing buildings or built features on the site 		
	<ul style="list-style-type: none"> • location and important characteristics of adjacent public, communal and private open spaces 		
	<ul style="list-style-type: none"> • location and height of existing windows, balconies, walls and fences on adjacent properties facing the site, as well as parapet and ridge lines 		
	<ul style="list-style-type: none"> • pedestrian and vehicular access points, driveways and features such as service poles, bus stops, fire hydrants etc. 		
	<ul style="list-style-type: none"> • location of utility services, including easements and drainage 		
	<ul style="list-style-type: none"> • location of any other relevant features 		

Documentation	Required information	Provided	
		Yes (✓)	No (x)
Streetscape elevations and sections	Photographs or drawings of the site in relation to the streetscape and along both sides of any street that the development fronts, that show:		
	<ul style="list-style-type: none"> • overall height (storeys, metres) and important parapet/datum lines of adjacent buildings 		
	<ul style="list-style-type: none"> • patterns of building frontage, street setbacks and side setbacks 		
	<ul style="list-style-type: none"> • planned heights 		
Analysis	Plan that synthesises and interprets the context, streetscape and site documentation into opportunities and constraints that generate design parameters, including the following information:		
	<ul style="list-style-type: none"> • orientation and any overshadowing of the site and adjoining properties by neighbouring structures (excludes vegetation). The winter sun path should also be shown between 9 am and 3 pm on 21 June 		
	<ul style="list-style-type: none"> • identification of prevailing wind 		
	<ul style="list-style-type: none"> • the geotechnical characteristics of the site and suitability of the proposed development 		
	<ul style="list-style-type: none"> • the public domain interface and street setback 		
	<ul style="list-style-type: none"> • relationship to and interface with adjacent properties, including side and rear setbacks 		
	<ul style="list-style-type: none"> • ventilation for the subject site and immediate neighbours 		
	<ul style="list-style-type: none"> • proposed building footprint location 		
	<ul style="list-style-type: none"> • retained and proposed significant trees and deep soil zones 		
	<ul style="list-style-type: none"> • proposed communal open space 		
	<ul style="list-style-type: none"> • proposed car park footprint and depth 		
	<ul style="list-style-type: none"> • proposed building entries 		
<ul style="list-style-type: none"> • supporting written material - this should include technical advice from specialists involved in the development process including landscape architects, arborists, geotechnical engineers and/or contamination specialists where applicable 			

APPENDIX 2

Pre-development application design proposal checklist

This Apartment Design Guide encourages pre-development application (pre-DA) discussions. To ensure maximum benefit of pre-DA discussions, consent authorities should appoint an urban designer or architect to provide specialist design advice. This may be a member of the Design Review Panel. Early input about the design may help to resolve issues prior to a development application being submitted.

Where a council requests panel members to attend a pre-DA discussion, it should be held at a regular time, and before the scheduled Design Review Panel meeting.

Pre-DA discussions are a critical component of the development process. Meeting early in the process allows for discussion and agreement of the overall design approach. This provides greater efficiency at the development assessment stage and also saves time and costs associated with revisions or major modifications. Minutes from pre-DA discussions should be issued by the consent authority within one week of the meeting or as soon as available.

The adjacent table shows the basic information that should be provided by the applicant before the pre-DA discussion. The emphasis should be on having enough information to communicate the proposal rather than having fully resolved drawings of every aspect of the project.

Documentation	Required information	Provided	
		Yes (✓)	No (x)
Development details	A summary of the proposal that establishes the: <ul style="list-style-type: none"> • Floor space ratio • Building height in metres and storeys • Number and mix of apartments • Number of car parking spaces • Indicative percentage of apartments receiving the minimum level of cross ventilation and daylight access 		
Design quality statement	A draft statement of key points that establishes how the proposal satisfies the design quality principles of State Environmental Planning Policy No. 65		
Precedents	Images of precedents relevant to the proposal such as: <ul style="list-style-type: none"> • streetscape concept • landscape design • communal open spaces use • building elements such as entries, balconies, materials 		
Site analysis	Prepared consistent with Appendix 1 of the Apartment Design Guide		
Site plan	A drawing to scale showing: <ul style="list-style-type: none"> • any proposed site amalgamation or subdivision • the indicative footprint of the proposal • setbacks and building separation dimensions • site entry points • areas of communal open space and private open space • indicative locations of planting and deep soil zones including retained or proposes significant trees • interface with public domain 		
Floor plans	Drawings to scale showing: <ul style="list-style-type: none"> • the internal building layout and unit type distribution for the ground floor, representative middle floor, and the top floor • typical car park layout • sample unit plans with furniture layouts, key room depth dimensions and balcony sizes 		
Building mass elevations	Drawing to scale showing the basic massing of the proposal in the context of the adjacent three properties, or for 50m in each direction, on each elevation. This drawing should show, in diagrammatic form: <ul style="list-style-type: none"> • the composition of the elevations including ground level, roof form, and articulation of massing of the overall building • pattern of buildings and spaces between buildings along the street • the profile of any existing buildings 		
Sections	A drawing to scale showing: <ul style="list-style-type: none"> • the proposal and adjacent buildings • the relationship of the proposal to the ground plane, streets, open spaces and deep soil zones 		

APPENDIX 3

Development application – recommended documentation checklist

Information required in a development application is established in Schedule 1 of the *Environmental Planning and Assessment Regulation 2000*. For residential apartment development, SEPP 65 provides additional recommendations for development application requirements.

The following table elaborates on the SEPP recommendations and is a guide that suggests more detailed and well resolved drawings to assist with demonstrating better design practice. The consent authority may also identify additional information that is required for the assessment of a residential apartment development. All plans, elevations and sections should be drawn to scale and include a graphic scale bar and true north point. A cover page with drawing list and BASIX commitments should be included.

Documentation	Required information	Provided	
		Yes (✓)	No (x)
Development details	A summary document that provides the key details of the development proposal. It contains information such as the:		
	<ul style="list-style-type: none"> • floor space ratio of the development 		
	<ul style="list-style-type: none"> • number, mix, size and accessibility of apartments 		
	<ul style="list-style-type: none"> • number of car parking spaces for use (residential, retail, accessible, visitor etc.) 		
Statement of Environmental Effects	<ul style="list-style-type: none"> • percentage of cross ventilation and daylight compliance 		
	In addition to the consent authorities requirements:		
	<ul style="list-style-type: none"> • An explanation of the design in terms of the design quality principles set out in Schedule 1 of <i>State Environmental Planning Policy No 65 - Design Quality of Residential Apartment Development</i> 		
	<ul style="list-style-type: none"> • If the proposed development is within an area where the built form and density is changing, statements about how the proposed development responds to the existing context and contributes to desired future character of the area 		
Site analysis	<ul style="list-style-type: none"> • Description of how the proposed development achieves the relevant objectives and design criteria of the Apartment Design Guide 		
	Prepared consistent with Appendix 1 of the Apartment Design Guide		

Documentation	Required information	Provided	
		Yes (✓)	No (x)
Site plan	A scale drawing showing:		
	<ul style="list-style-type: none"> any proposed site amalgamation or subdivision 		
	<ul style="list-style-type: none"> location of any proposed buildings or works in relation to setbacks, building envelope controls and building separation dimensions 		
	<ul style="list-style-type: none"> proposed finished levels of land in relation to existing and proposed buildings and roads 		
	<ul style="list-style-type: none"> pedestrian and vehicular site entries and access 		
	<ul style="list-style-type: none"> interface of the ground floor plan with the public domain and with open spaces within the site 		
	<ul style="list-style-type: none"> areas of communal open space and private open space 		
	<ul style="list-style-type: none"> indicative locations of planting and deep soil zones including retained or proposed significant trees 		
Landscape plan	A scale drawing showing:		
	<ul style="list-style-type: none"> the building footprint of the proposal including pedestrian, vehicle and service access 		
	<ul style="list-style-type: none"> trees to be removed shown dotted 		
	<ul style="list-style-type: none"> trees to remain with their tree protection zones (relative to the proposed development) 		
	<ul style="list-style-type: none"> deep soil zones and associated tree planting 		
	<ul style="list-style-type: none"> areas of planting on structure and soil depth 		
	<ul style="list-style-type: none"> proposed planting including species and size 		
	<ul style="list-style-type: none"> details of public space, communal open space and private open space 		
	<ul style="list-style-type: none"> external ramps, stairs and retaining wall levels 		
	<ul style="list-style-type: none"> security features and access points 		
	<ul style="list-style-type: none"> built landscape elements (fences, pergolas, walls, planters and water features) 		
	<ul style="list-style-type: none"> ground surface treatment with indicative materials and finishes 		
	<ul style="list-style-type: none"> site lighting 		
	<ul style="list-style-type: none"> water management and irrigation concept design 		

Documentation	Required information	Provided	
		Yes (✓)	No (x)
Floor plans	A scale drawing showing:		
	<ul style="list-style-type: none"> all levels of the building including roof plan 		
	<ul style="list-style-type: none"> layout of entries, circulation areas, lifts and stairs, communal spaces, and service rooms with key dimensions and RLs shown 		
	<ul style="list-style-type: none"> apartment plans with apartment numbers and areas, all fenestration, typical furniture layouts for each apartment type, room dimensions and intended use and private open space dimensions 		
	<ul style="list-style-type: none"> accessibility clearance templates for accessible units and common spaces 		
	<ul style="list-style-type: none"> visual privacy separation shown and dimensions where necessary 		
	<ul style="list-style-type: none"> vehicle and service access, circulation and parking 		
	<ul style="list-style-type: none"> storage areas 		
Elevations	A scale drawing showing:		
	<ul style="list-style-type: none"> proposed building height and RL lines 		
	<ul style="list-style-type: none"> building height control 		
	<ul style="list-style-type: none"> setbacks or envelope outline 		
	<ul style="list-style-type: none"> building length and articulation 		
	<ul style="list-style-type: none"> the detail and features of the facade and roof design 		
	<ul style="list-style-type: none"> any existing buildings on the site 		
	<ul style="list-style-type: none"> building entries (pedestrian, vehicular and service) 		
	<ul style="list-style-type: none"> profile of buildings on adjacent properties or for 50m in each direction, whichever is most appropriate 		
Sections	A scale drawing showing:		
	<ul style="list-style-type: none"> proposed building height and RL lines 		
	<ul style="list-style-type: none"> building height control 		
	<ul style="list-style-type: none"> setbacks or envelope outline 		
	<ul style="list-style-type: none"> adjacent buildings 		
	<ul style="list-style-type: none"> building circulation 		
	<ul style="list-style-type: none"> the relationship of the proposal to the ground plane, the street and open spaces particularly at thresholds 		

Documentation	Required information	Provided	
		Yes (✓)	No (x)
Sections (continued)	<ul style="list-style-type: none"> the location and treatment of car parking 		
	<ul style="list-style-type: none"> the location of deep soil and soil depth allowance for planting on structure (where applicable) 		
	<ul style="list-style-type: none"> building separation within the development and between neighbouring buildings 		
	<ul style="list-style-type: none"> ceiling heights throughout the development 		
	<ul style="list-style-type: none"> detailed sections of the proposed facades 		
Solar access study	Where required, graphic documentation at winter solstice (21 June) at a minimum of hourly intervals showing:		
	<ul style="list-style-type: none"> number of hours of solar access to the principal communal open space 		
	<ul style="list-style-type: none"> number of hours of solar access to units within the proposal and tabulation of results 		
	<ul style="list-style-type: none"> overshadowing of existing adjacent properties and overshadowing of future potential development where neighbouring sites are planned for higher density 		
	<ul style="list-style-type: none"> elevation shadows if shadow is likely to fall on neighbouring windows, openings or solar panels 		
Cross ventilation study	Where required, graphic documentation of unobstructed path of air movement through dual aspect apartments and tabulation of results		
Material and finishes board	A sample board of the proposed external materials, finishes and colours of the proposal, keyed to elevations		
Illustrative views	<p>Photomontages or similar rendering or perspective drawings illustrating the proposal in the context of surrounding development.</p> <p><i>Note: Illustrative views need to be prepared using a perspective that relates to the human eye. Where a photomontage is prepared, it should use a photo taken by a full frame camera with a 50mm lens and 46 degree angle of view</i></p>		
Models	<ul style="list-style-type: none"> A three dimensional computer generated model showing views of the development from adjacent streets and buildings 		
	<ul style="list-style-type: none"> A physical model that shows the massing of the proposal that includes relevant context (particularly for developments of 20 apartments or more, or on contentious sites) if required by the consent authority 		

APPENDIX 4

Apartment building types - Example schemes

01

Narrow infill apartment



This example scheme divides the built form into two components, a front component that addresses the street to the south and a longer rear building positioned perpendicular to the street alignment.

The front building faces the street and provides a unified streetscape. This allows for a prominent building entry as well as overlooking of the street from balconies and windows of apartments. One of the side setbacks of the front building is able to be reduced to 3 metres as the side wall has no windows to the neighbour. The rear component has increased setbacks to resolve privacy and overshadowing impacts to adjoining properties. Ground floor apartments are two levels and accessed from a private courtyard.

The building height relates to the area's desired future character. Height is also determined by sunlight access requirements to communal and private spaces for this development and its neighbours, and changes from 4 storeys at the street frontage to 3 storeys at the rear. This change in height also provides an opportunity for a roof garden.

Dual aspect apartments (dwellings with windows and/or balconies to at least two sides) allow for a high level of amenity for residents. Likewise the setbacks provide areas for communal open space, deep soil and retention of significant trees. The split level basement parking area is accessed from a single point on the lower side of the street frontage.

Context and subdivision

Suburban infill site in an area undergoing transition from detached dwellings to residential flat buildings; the site is a consolidation of two detached housing lots

Key considerations

- visual privacy and sunlight access to proposed apartments and adjoining properties
- visual impact of vehicle access to car park

Design qualities

- all proposed apartments are dual aspect and offer natural cross ventilation
- daylight access is shared equitably

Dimensions and data

Site dimensions: 20m wide x 50m deep

Site area: 1,000m²

Building height: 3-4 storeys above ground

FSR: 1.1:1

Building depth: 9.5-13m

Setbacks: front setback consistent with established pattern in street; side setback 3-4m; rear setback 6m

Deep soil: 40%

Car parking: 15 spaces (basement)

Number of dwellings and mix:
11 apartments with a mix of 1 and 2 bedrooms

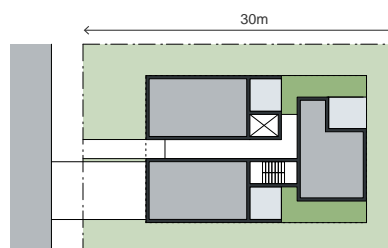

Narrow infill apartment types are modular and can be adapted to fit various site depths. This example is situated on a 30m deep lot

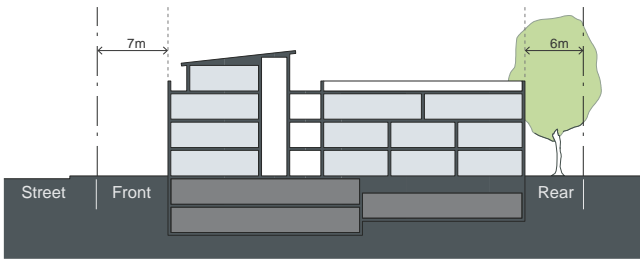

Proposed development - Section A

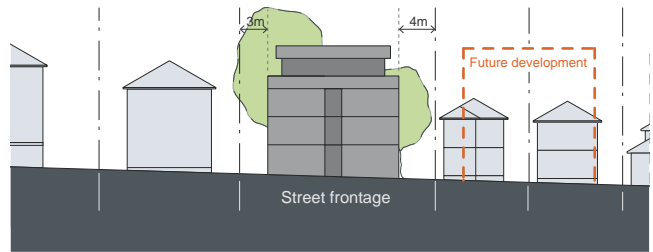

Proposed development - Street elevation

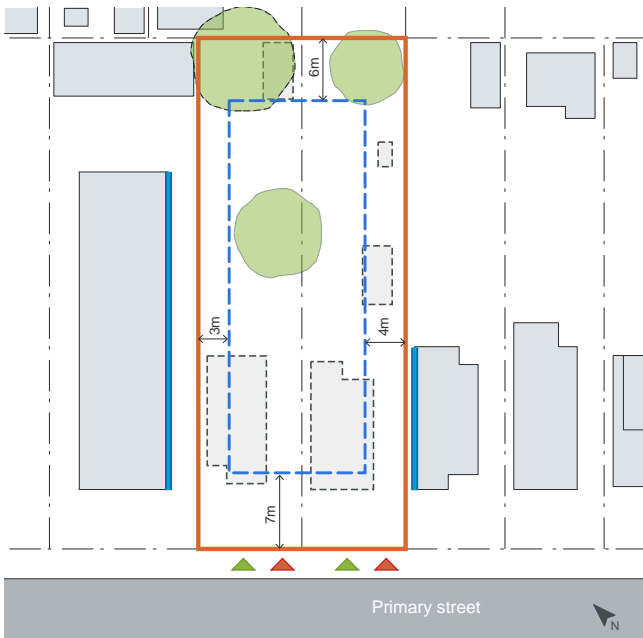

Existing site and proposed development footprint



Proposed development - Typical ground level plan

- Site boundary
- - - Proposed development footprint
- ▲ Pedestrian access
- ▼ Vehicular access
- Deep soil zone
- Significant tree to be retained
- Walls with balconies or windows to habitable rooms

Apartment building types - Example schemes

02

Row apartments



This example scheme of a row apartment type uses two separate volumes to step down the street in response to the site slope and the height of neighbouring buildings. To further integrate with the neighbourhood character, the front of the building is aligned with adjacent properties to achieve a consistent setback and open space character.

Building entries, balconies and windows address the street and provide passive surveillance, while non-habitable rooms face the side boundaries. A generous rear setback allows for visual privacy and ensures solar access to private open spaces.

Site amenity is maximised by providing deep soil areas which incorporate the existing significant vegetation in both the front and rear setbacks. Vehicle access is restricted to a single access point and basement car parking is contained within the building footprint.



Row apartment types are modular and can be adapted to fit various site widths. They are well suited to wide, shallow lots and typically have 2-3 apartments accessed off one common access core

Context and subdivision

The site is a consolidation of three narrow residential lots, located in a suburban area undergoing an increase in density with a mix of detached, duplex, terrace and apartment buildings

Key considerations

- character of the area and streetscape
- visual privacy and overshadowing of adjacent properties
- retention of existing trees

Design qualities

- building scale (3 levels + 4th level setback) relates well to existing urban character
- dual aspect apartments with good daylight access and natural ventilation
- good visual privacy for residents and neighbours with balconies facing the street and rear garden

Data

Site dimensions: 33m wide x 33.5m deep

Site area: 1,100m²

Building height: 3-4 storeys above ground

FSR: 1:1

Building depth: 17m (including balconies)

Setbacks: front setback consistent with established pattern in street; side setback 3m; rear setback 10m

Deep soil: 35%

Car parking: 17 spaces (basement)

Number of dwellings and mix:
12 apartments, predominantly 2 bedrooms

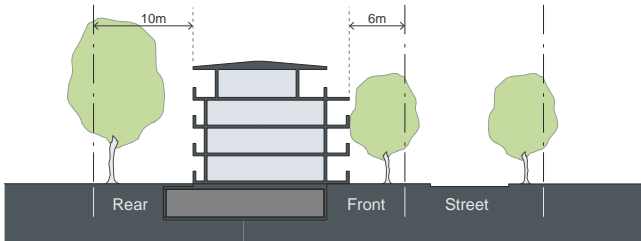

Proposed development - Section A

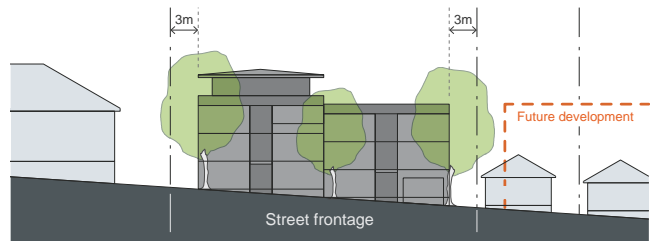

Proposed development - Street elevation

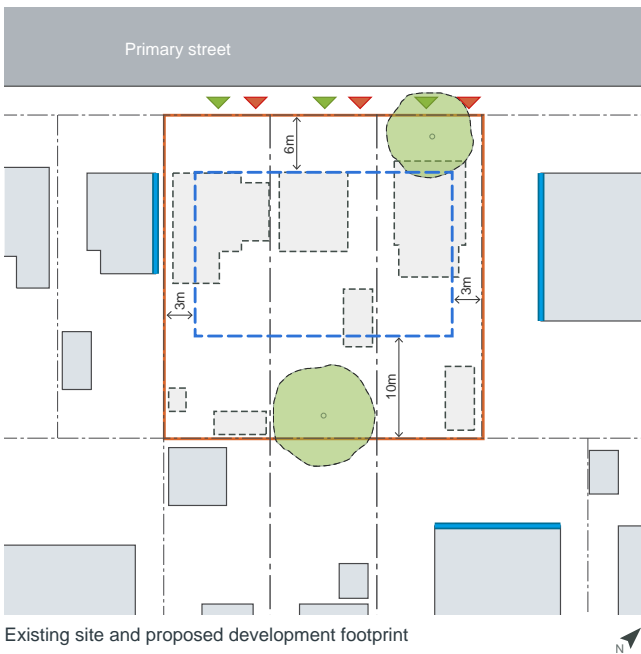

Existing site and proposed development footprint

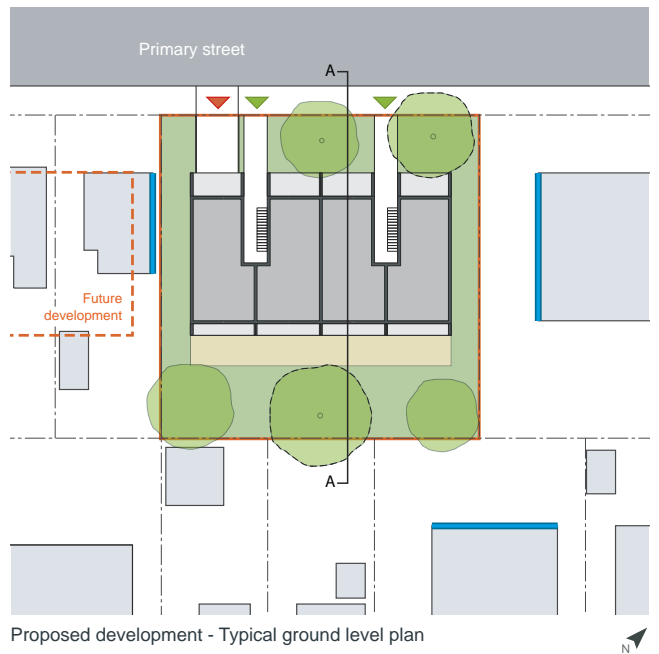

Proposed development - Typical ground level plan

- Site boundary
- - - Proposed development footprint
- ▲ Pedestrian access
- ▼ Vehicular access
- Deep soil zone
- Significant tree to be retained
- Walls with balconies or windows to habitable rooms

Apartment building types - Example schemes

03

Shop top apartments

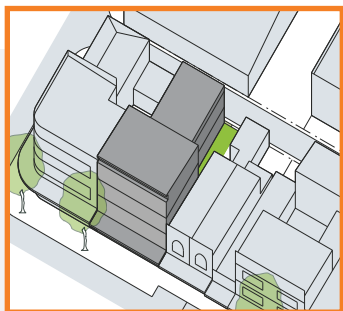

This example scheme adopts the established building alignment, responds to the fine urban grain of the main street and provides for a continuous awning along the street frontage.

Above the retail and to the rear of the site, a mix of 1 and 2 bed apartments are located in a 'T' configuration of 3 to 4 storeys. The front building extends to side boundaries to provide a continuous street wall. Dual aspect apartments ensure good daylight access and natural ventilation.

The building to the rear is perpendicular to the main street and setback from both side and rear boundaries. This provides amenity benefits including a small courtyard space, privacy to residents and neighbouring dwellings and access to sunlight. Solutions such as adjustable screens may be required on the northern elevation to manage privacy impacts.

Access for the residential apartments is separated from access to the ground floor retail, enhancing safety. Likewise access from the main street and rear lane, as well as the layout of apartments facilitates passive surveillance to both the main street and rear lane, increasing safety and security.

The rear lane provides access to a single level basement car park with planting above the basement structure. Where possible, opportunities to create or retain deep soil zones within side and rear setbacks should be explored on sites similar to this example.

Context and subdivision

Urban main street undergoing renewal; heights range between 2 and 3 storeys and buildings are built to the street alignment; the development site is a consolidation of three retail terrace lots fronting a busy road to the north-west and laneway to the south-east; adjacent development includes a mix of three storey shop top apartments and 2 storey retail buildings

Key considerations

- heritage values of adjacent buildings and retention of streetscape character
- interface between residential and non-residential uses
- visual privacy and noise impacts

Design qualities

- more homes within a local centre in walkable distance to services and facilities
- continuous street wall height and proportion
- activation and increased surveillance of rear lane

Dimensions and data

Site dimensions: 15m wide x 30m deep

Site area: 450m²

Building height: 3-4 storeys above ground

FSR: 1.8:1

Building depth: 7.5-12m

Setbacks: zero front setback consistent with established pattern in street; zero side setback; rear setback 3m

Deep soil: 13%

Car parking: 7 spaces (basement)

Retail GFA: 100m² (ground floor)

Number of dwellings and mix:
9 apartments with a mix of 1 and 2 bedrooms

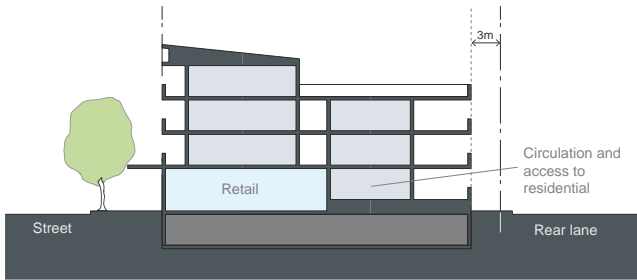

Proposed development - Section A

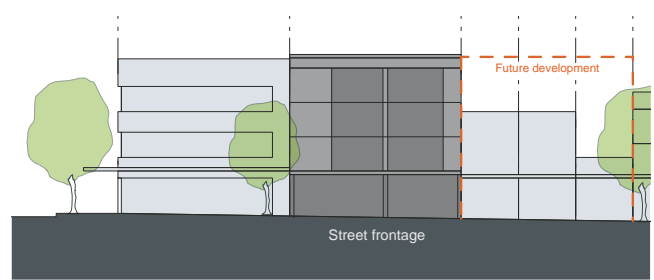

Proposed development - Street elevation

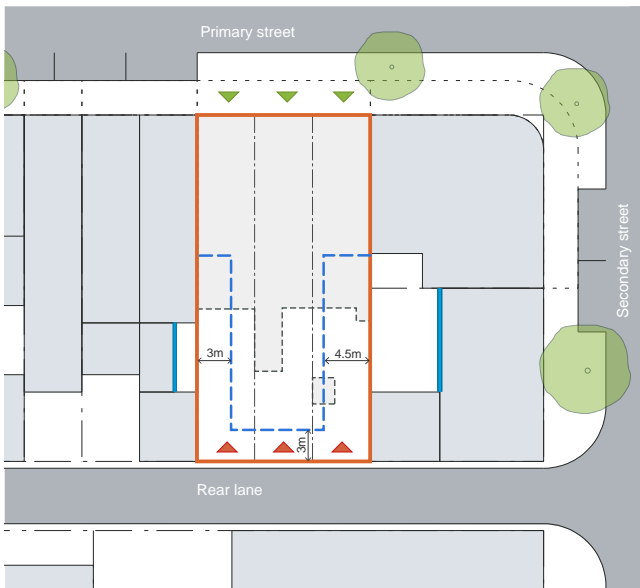

Existing site and proposed development footprint

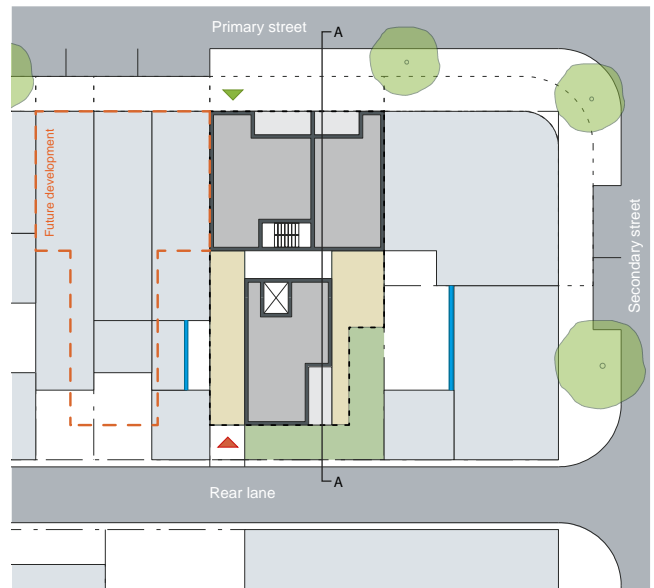

Proposed development - Typical upper level plan

- Site boundary
- - - Proposed development footprint
- ▶ Pedestrian access
- ▶ Vehicular access
- Deep soil zone
- Significant tree to be retained
- Walls with balconies or windows to habitable rooms

Apartment building types - Example schemes

04

Courtyard apartments (U-shape)

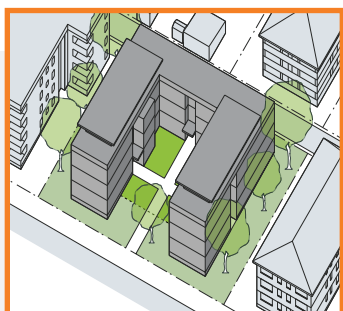

This example of a U-shaped courtyard apartment building addresses both the primary street frontage and the rear lane which increases safety by encouraging activity and surveillance. Access points to apartments from the courtyard are clearly defined by three access cores which help to break up the building into smaller masses and contribute to better surveillance, daylight access and natural ventilation.

The prominent central courtyard present an attractive landscaped setting to the street. Surveillance of the central courtyard and side boundaries is achieved from balconies and windows. In this example and on properties with similar characteristics the transition from public to private space should be carefully considered and managed.

Visual privacy and daylight access to adjacent sites is allowed for by appropriate building separation and height. Amenity within the site is achieved through a 12m building separation (courtyard) and a building orientation that enables an attractive outlook and good daylight access. Larger side setbacks provide opportunities to retain significant trees and vehicle access is off the rear lane.

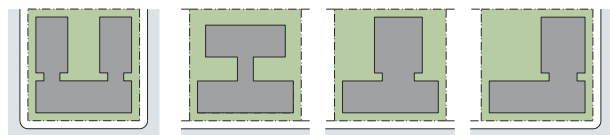

Courtyard apartment types can take many forms depending on the site configuration and orientation and be adapted or combined accordingly

Context and subdivision

Suburban area undergoing transition from detached dwellings to residential flat buildings; two lots have been consolidated to form the development site; dual frontage to street and rear lane

Key considerations

- visual privacy for adjoining properties
- overshadowing of courtyard
- design of corners to ensure good daylight access to apartments

Design qualities

- activates both the street and the rear lane
- communal courtyard increases opportunities for social interaction for residents
- integration with neighbourhood character by orienting either the short ends or the long frontage to the street
- suited to step with the slope and be oriented to capture views, daylight and prevailing breezes
- suitable to respond to a variety of lots shapes

Dimensions and data

Site dimensions: 43m wide x 35m deep

Site area: 1,470m²

Building height: 3-4 storeys above ground

FSR: 1:1

Building depth: 7m - 10m

Setbacks: front setback consistent with established pattern in street; side setback 6m; rear setback 3m, courtyard (between buildings) 12m

Deep soil: 30%

Car parking: 22 spaces (basement)

Retail component: 100m² ground floor

Number of dwellings and mix:

19 apartments with a mix of 1, 2 and 3 bedrooms

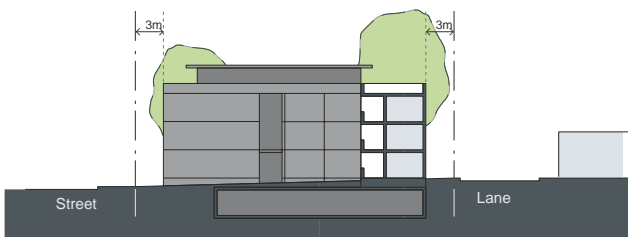

Proposed development - Section A

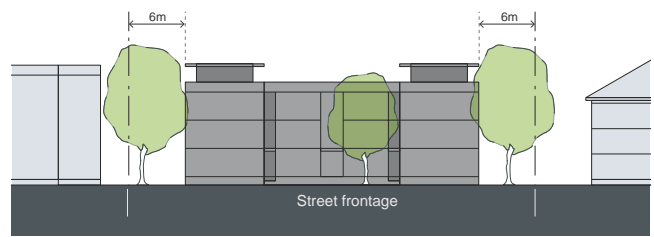

Proposed development - Street elevation

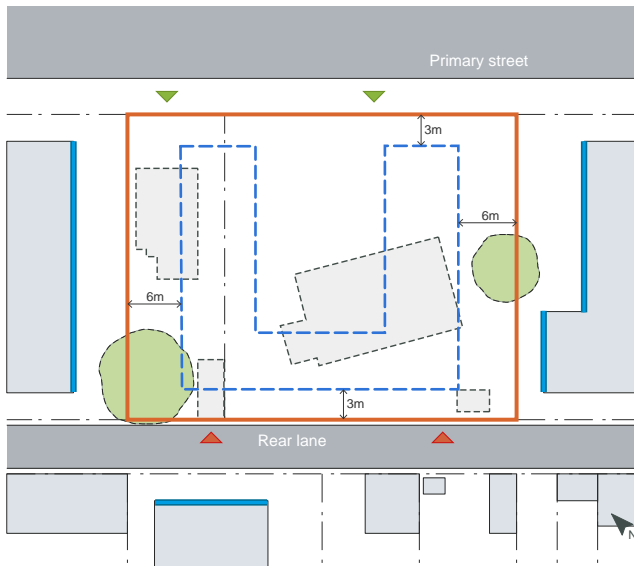

Existing site and proposed development footprint



Proposed development - Typical ground level plan

- Site boundary
- - - Proposed development footprint
- ▲ Pedestrian access
- ▲ Vehicular access
- Deep soil zone
- Significant tree to be retained
- Walls with balconies or windows to habitable rooms

Apartment building types - Example schemes

05

Courtyard apartments (linear)

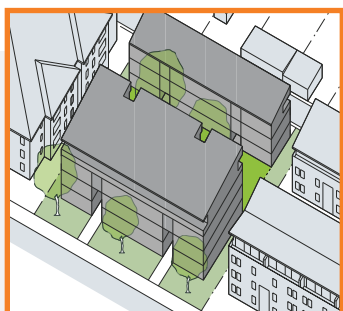

This example uses a centralised courtyard between two linear buildings to optimise development of the site while ensuring good amenity. By using this typology it is possible to provide consistent setbacks to the street and lane, a sense of address and good surveillance of the public domain.

Building height should relate to the adjacent development, street width and the direction of solar access. In this example, the larger 4 storey building fronts the wider street while the 3 storey building is oriented to the north and fronts the narrower lane. This lower building height allows for sunlight to access to the courtyard behind.

Amenity to neighbouring properties is improved by providing greater visual privacy and improved daylight and sunlight access than would otherwise be possible with a building perpendicular to the street alignment. Walls facing the side boundary are mostly blank with windows only to common entry corridors and non-habitable rooms. This improves the privacy to adjacent properties that have habitable windows and balconies facing the side boundary.

A centralised courtyard provides separation between facades and a pleasant open space for passive recreation. The courtyard also provides opportunities to retain any significant vegetation and overlap deep soil with communal open space. In addition, planting on top of the car park increases the attractiveness and usability of this area. Vehicle access is from the lane to a split level car park which is located predominantly below the building footprint.

Context and subdivision

Suburban area in transition to increased density with a mix of apartment buildings and detached dwellings; the development site is an amalgamation of four traditional detached housing lots with street and rear lane frontage

Key considerations

- visual privacy for adjoining properties
- adequate building separation to ensure good solar access and ventilation

Design qualities

- multiple building entries achieve activation of the street and rear lane
- front building forms part of an intended street wall
- can be adapted for narrow sites and include SOHO units (live/work) or small commercial tenancies
- suitable for sloping sites

Dimensions and data

Site dimensions: 45m wide x 40m deep

Site area: 1,800m²

Building height: 3-4 storeys above ground

FSR: 1.3:1

Building depth: 7.8m - 16.2m

Setbacks: front setback consistent with established pattern in street; side setback 3m

Deep soil: 20%

Car parking: 25 spaces (basement)

Number of dwellings and mix:
22 apartments with a mix of 1, 2 and 3 bedrooms



Proposed development - Section A

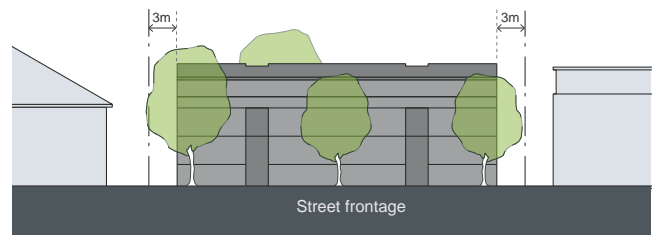

Proposed development - Street elevation

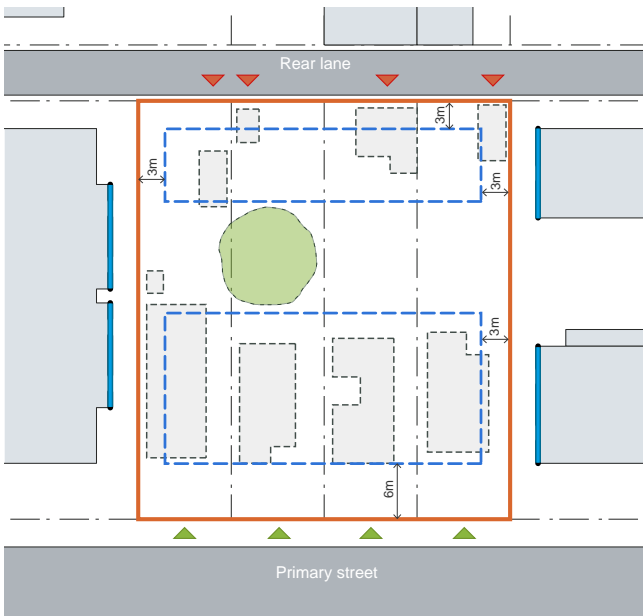

Existing site and proposed development footprint



Proposed development - Typical ground level plan

- Site boundary
- - - Proposed development footprint
- ▲ Pedestrian access
- ▼ Vehicular access
- Deep soil zone
- Significant tree to be retained
- Walls with balconies or windows to habitable rooms

Apartment building types - Example schemes

06

Perimeter block apartments

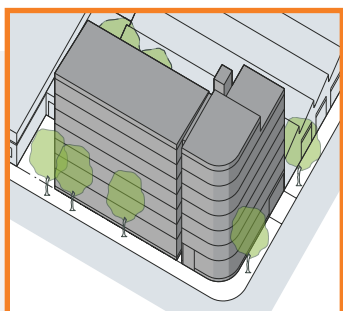

This example uses a perimeter block building to align the development with both street edges and clearly define the street corner. The building is constructed to the side boundaries in anticipation of future development and has a desired continuous street wall height for the area.

Residential apartments are set above the noisy street level. Noise impacts are buffered by balconies and adjustable screens. Two storey apartments are arranged along an open gallery to maximise northern solar access, while single storey apartments are located towards the corner adjacent to the lift core.

Privacy within the site and to future neighbouring residential apartment development is achieved through a rear boundary setback. This also creates space for a communal courtyard with deep soil zones and landscaping on the top of the basement structure. Vehicle access is off the secondary street and designed to minimise safety risks for pedestrians.

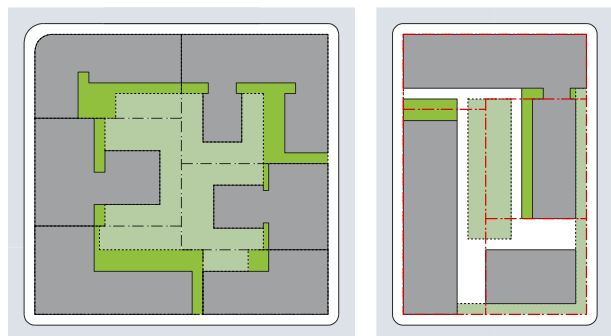

Perimeter blocks can be delivered in stages and over time. They are often designed as a series of buildings which share a central communal open space and/or basement car parking

Context and subdivision

Former industrial area under transition into urban neighbourhood; the site is located on a street corner and surrounded by industrial sheds and several new apartment buildings

Key considerations

- visual privacy and good daylight access to neighbouring properties
- relationship and interface between residential and non-residential uses
- emphasis on design of corner component

Design qualities

- clearly defines the visually prominent street corner
- supports a vibrant neighbourhood by creating active retail frontages at ground level facing the street
- offers high residential amenity due to shallow building depth and dual aspect apartments
- defines the desired future streetscape scale

Dimensions and data

Site dimensions: 41m wide x 23m deep

Site area: 950m²

Building height: 6-7 storeys above ground

FSR: 3.3:1

Building depth: 9.6m - 13.5m

Setbacks: zero front setback consistent with established pattern in street; zero side and rear setback

Deep soil: 13%

Car parking: 38 spaces (basement)

Number of dwellings and mix:
29 apartments with a mix of 2 and 3 bedrooms

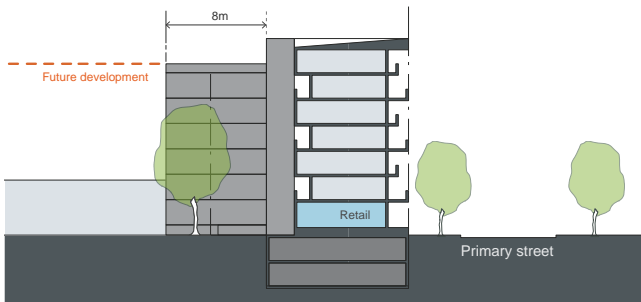

Proposed development - Section A

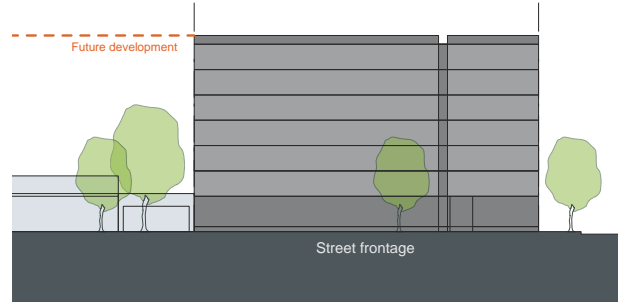

Proposed development - Street elevation

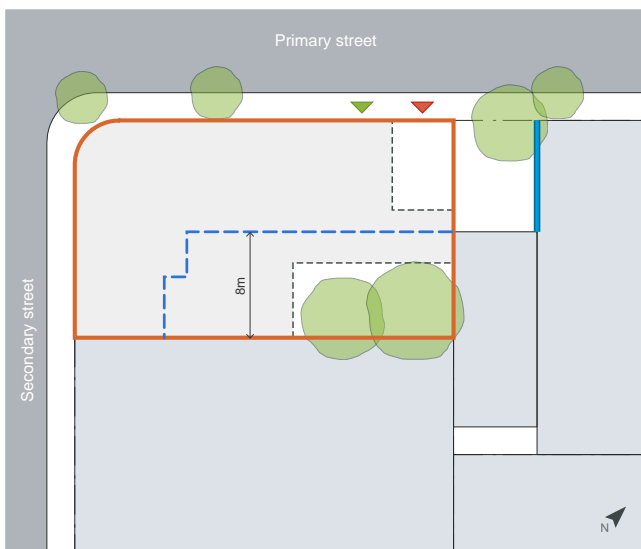

Existing site and proposed development footprint

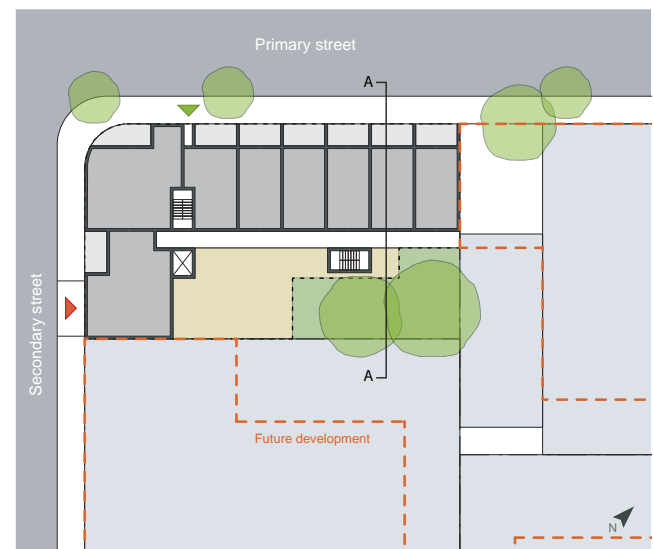

Proposed development - Typical upper level plan

- Site boundary
- - - Proposed development footprint
- ▲ Pedestrian access
- ▼ Vehicular access
- Deep soil zone
- Significant tree to be retained
- Walls with balconies or windows to habitable rooms

Apartment building types - Example schemes

07

Tower apartments (podium)

This example consists of three distinct built form components: a ground floor retail level with full site coverage, a podium with commercial floors and a residential tower. The building integrates with its context by building to the street alignment and providing a street wall height that is consistent with the typical range of the area.

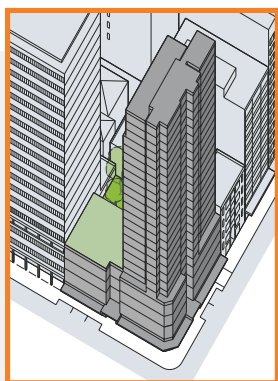

The ground floor interface balances the need for flexible use of space with the potential for varied tenancy sizes that encourage activation and a vibrant street life. Commercial floors above the ground level retail act as a buffer and vertically separate noisy areas from upper level apartments. Entries to the residential lobbies are directly accessible from the street, and are distinctly separate from retail and commercial entrances.

While the tower has a repetitive floor layout, facade articulation offers the opportunity to group floors together and vary facade treatments to add interest. Each residential floor has eight apartments that are accessed from the lift core, with windows at the end of common corridors. Corner apartments are cross ventilated. Balconies at higher levels may need to be partially enclosed to resolve wind impacts, e.g. through operable louvres or wintergardens.

In highly urbanised locations, deep soil zones may be impractical to provide. This example compensates for the lack of deep soil by landscaping the roof of the podium, providing common open space for residents and environmental benefits through improving the local microclimate. Access to basement parking is from the secondary street frontage and integrated into the overall building design.

Context and subdivision

An inner city corner site with a mix of towers and street wall buildings; predominant street wall height ranges between 20m and 45m; podium buildings are constructed to the street alignment and have a zero setback to side boundaries

Key considerations

- visual impact of tower element
- visual privacy to neighbouring development
- overshadowing of communal and public space and neighbouring development

Design qualities

- provides housing in a centre or CBD
- residential uses activate the area outside of business hours (applicable to inner city or CBD location)
- podium provides a communal open space area for residents. It also integrates the building into the streetscape with a continuous street wall height
- opportunity to be a gateway building or landmark

Dimensions and data

Site dimensions: 46m wide x 38m deep

Site area: 1,750m²

Building height: 4 to 25 storeys above ground

FSR (retail): 2.8:1; FSR (residential): 8.4:1

Building depth (retail/commercial): 25m

Building depth (residential): 18m

Setbacks: zero front setback consistent with established pattern in street; zero side and rear setback

Deep soil: 0%, Planting on structure: 24%

Car parking: 110 spaces (basement)

Number of dwellings and mix:

150 apartments with a mix of studio, 1, 2 & 3 bedrooms

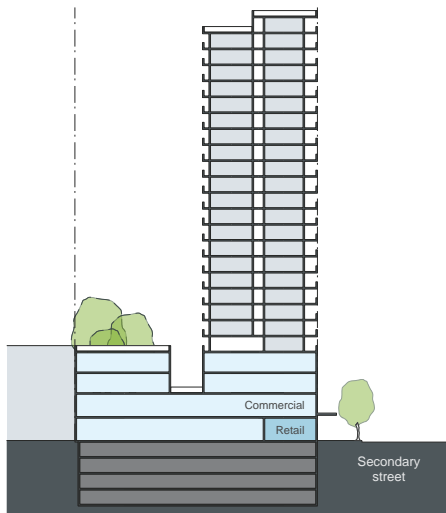

Proposed development - Section A

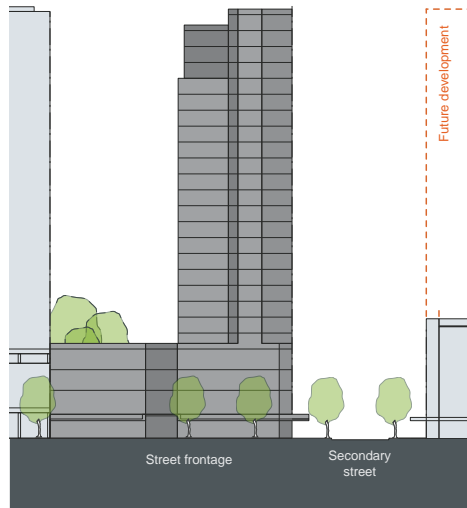

Proposed development - Street elevation

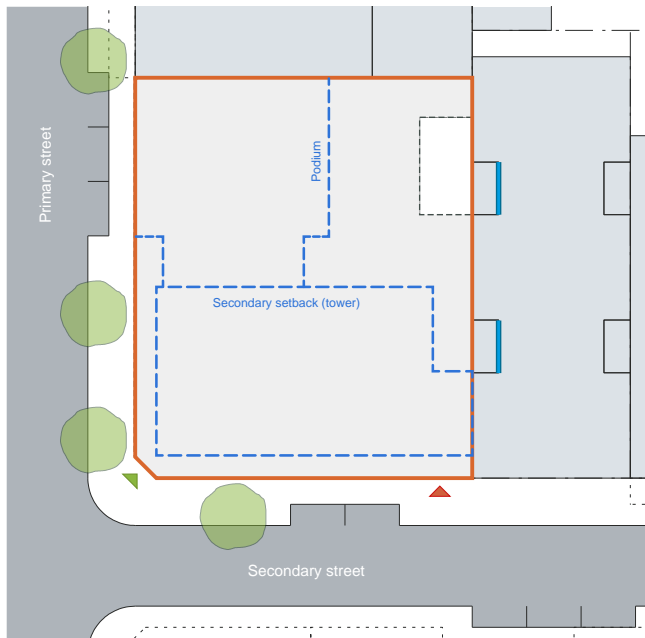

Existing site and proposed development footprint



Proposed development - Typical upper level plan

- Site boundary
- - - Proposed development footprint
- ▲ Pedestrian access
- ▲ Vehicular access
- Deep soil zone
- Significant tree to be retained
- Walls with balconies or windows to habitable rooms

Apartment building types - Example schemes

08

Tower apartments (freestanding)

This development integrates with its context by aligning with the setback of adjacent buildings and providing an address to surrounding streets. The location of the tower minimises overshadowing of communal and public open space and neighbouring development. The orientation of the building along the north-south axis maximises views and enables good solar access to all apartments.

Communal open space for residents is provided in the centre of the site facing the public park. The basement car park has a U-shaped footprint over two levels and wraps around a deep soil zone under the communal courtyard. Vehicle access is located on the secondary street to the south.

Pedestrian entries to lobbies are located along all street frontages. Additional access is provided from the public park to the north and off the communal courtyard. At ground level, apartments have direct access from the street or the communal courtyard and the design allows for live-work apartments and retail space facing the street.

The tower has a central core with eight apartments per floor. All circulation corridors have access to natural light and ventilation.

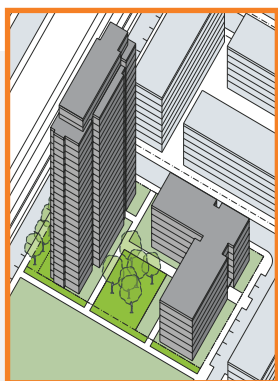

Context and subdivision

The site is located within a predominantly residential context at the edge of a town centre, adjacent to a (noisy) railway line to the east and defined by streets on three sides and a public park to the north

Key considerations

- visual impact of tower element
- visual privacy to neighbouring development
- overshadowing of communal and public space and neighbouring development
- relationship with streetscape

Design qualities

- small footprint minimises hard surface areas and reduces urban heat island effect
- excellent views, daylight access and natural ventilation for residents
- separation from noise sources (e.g. busy road/rail)
- opportunity to be a gateway building or landmark

Dimensions and data

Site dimensions: 95m wide x 62m deep

Site area: 5,890m²

Building height: 25 storeys above ground

FSR: 4.4:1

Building depth: 15.5m - 21.5m

Setbacks: landscaped setback, consistent with surrounding context

Deep soil: 14%

Car parking: 340 spaces (basement)

Number of dwellings and mix:
314 apartments with a mix of 1, 2 and 3 bedrooms

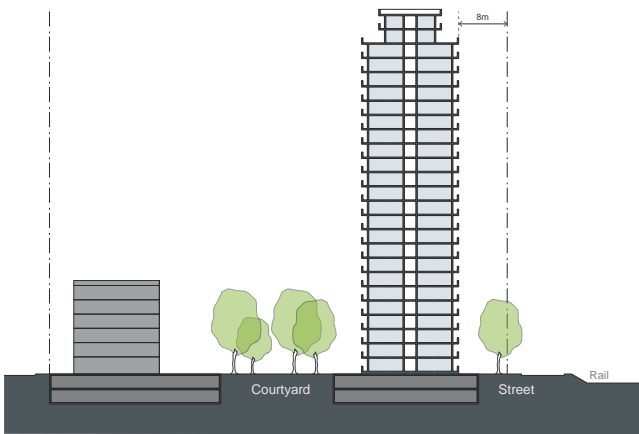

Proposed development - Section A



Proposed development - Street elevation

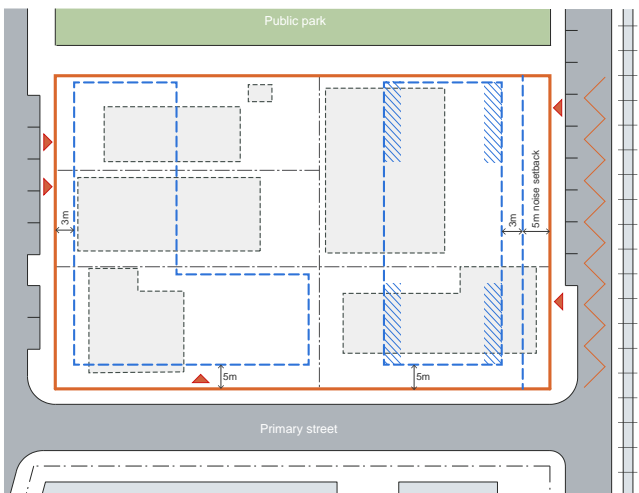

Existing site and proposed development footprint

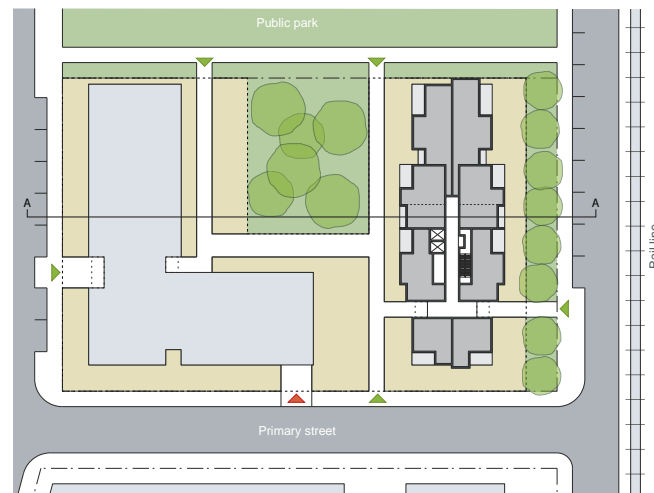

Proposed development - Typical upper level plan

- Site boundary
- Proposed development footprint
- ▶ Pedestrian access
- ▶ Vehicular access
- Deep soil zone
- Significant tree to be retained
- Walls with balconies or windows to habitable rooms

Apartment building types - Example schemes

09

Hybrid (mixed) development

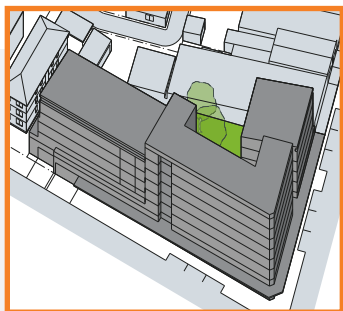

This example scheme of a mixed use development is an amalgamation of four lots and is located on a prominent street corner. It consists of a single level retail podium with full site coverage and residential apartments on the upper levels.

The sharp street corner is defined and both streets are addressed through the use of commercial frontages (windows and entries) and a continuous awning that turns the corner. Lift cores to residential floors above are located at the street edge. Single storey units are stacked vertically on the corner and accessed from an open gallery while crossover apartments to either side of the building maximise northern sunlight access.

Communal open space is provided on the podium with substantial planting on structure (roof garden). Large trees and adequate building separation further enhance residential amenity. Vehicle access to the basement car park and the retail loading dock are located off the secondary street to the north.

Integrating residential apartments with large format commercial uses requires detailed consideration to resolve potential conflicts between uses. The location of retail and residential entries, the arrangement of loading docks and basement car parking and the impact and mitigation of noise generated by the commercial component are some examples.

Context and subdivision

A prominent corner site that addresses two streets with different streetscape character; surrounding buildings are anticipated to redevelop into similar density and height; desired future character of the area includes active street frontages, continuous awnings, zero building alignments and street frontage heights of 17 to 24m

Key considerations

- relationship and activation of surrounding streets
- relationship and interface between residential and non-residential uses and mitigation of potential conflicts between them
- emphasis on design of prominent corner component

Design qualities

- clear street address with active frontages
- podium roof gardens add to residential amenity
- selection of robust facade materials
- integration of photo voltaics (PV) on roofs and awnings

Dimensions and data

Site dimensions: 80 x 45m (irregular)

Site area: 2,840m²

Building height: 5-7 storeys above ground

FSR: 2.8:1 residential and 0.8:1 retail

Building depth (residential): 10.2 - 17m

Setbacks: nil front setback, 2.4m front setback upper levels, nil side setback, 3m upper levels, nil rear setback, 9m upper levels

Deep soil zone: 0%, Planting on structure: 10%

Car parking: 210 spaces (basement) including parking for both residential and non-residential uses

Retail GFA: 2,270m² (ground floor)

Number of dwellings and mix:

64 apartments with a mix of 1, 2 and 3 bedrooms

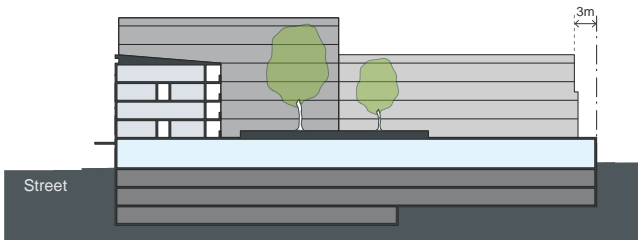

Proposed development - Section A



Proposed development - Street elevation

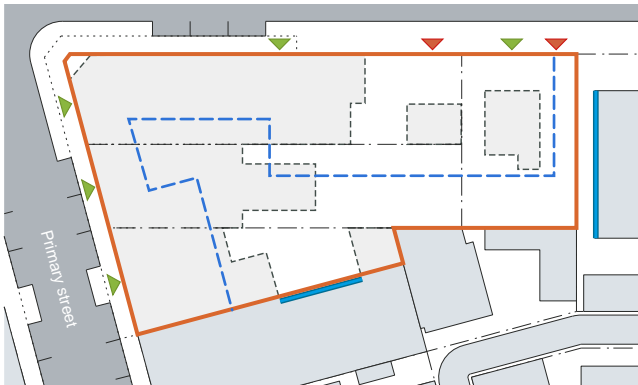

Existing site and proposed development footprint

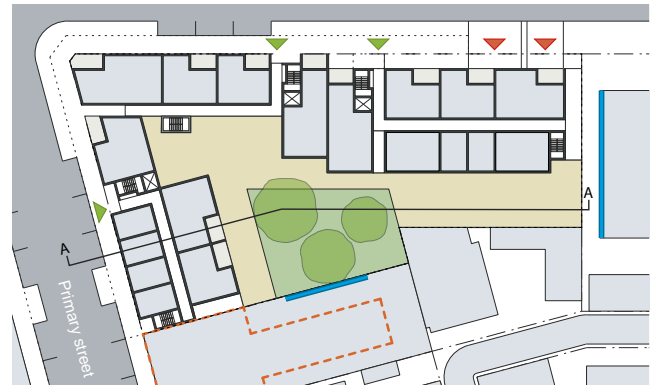

Proposed development - Typical upper level plan

- Site boundary
- - - Proposed development footprint
- ▲ Pedestrian access
- ▼ Vehicular access
- Deep soil zone
- Significant tree to be retained
- Walls with balconies or windows to habitable rooms

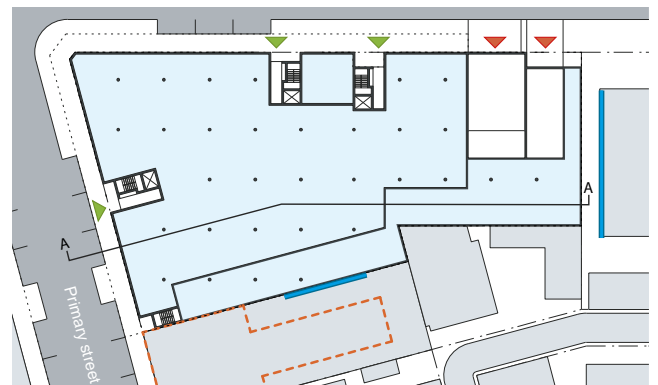

Proposed development - Ground level plan

APPENDIX 5

Sunlight access analysis tool

To achieve 2 hours of direct sunlight in mid winter, a good test is to check whether the sun can 'see' the living room window and private open space between 11 am and 1 pm in plan view

Sunlight access tool

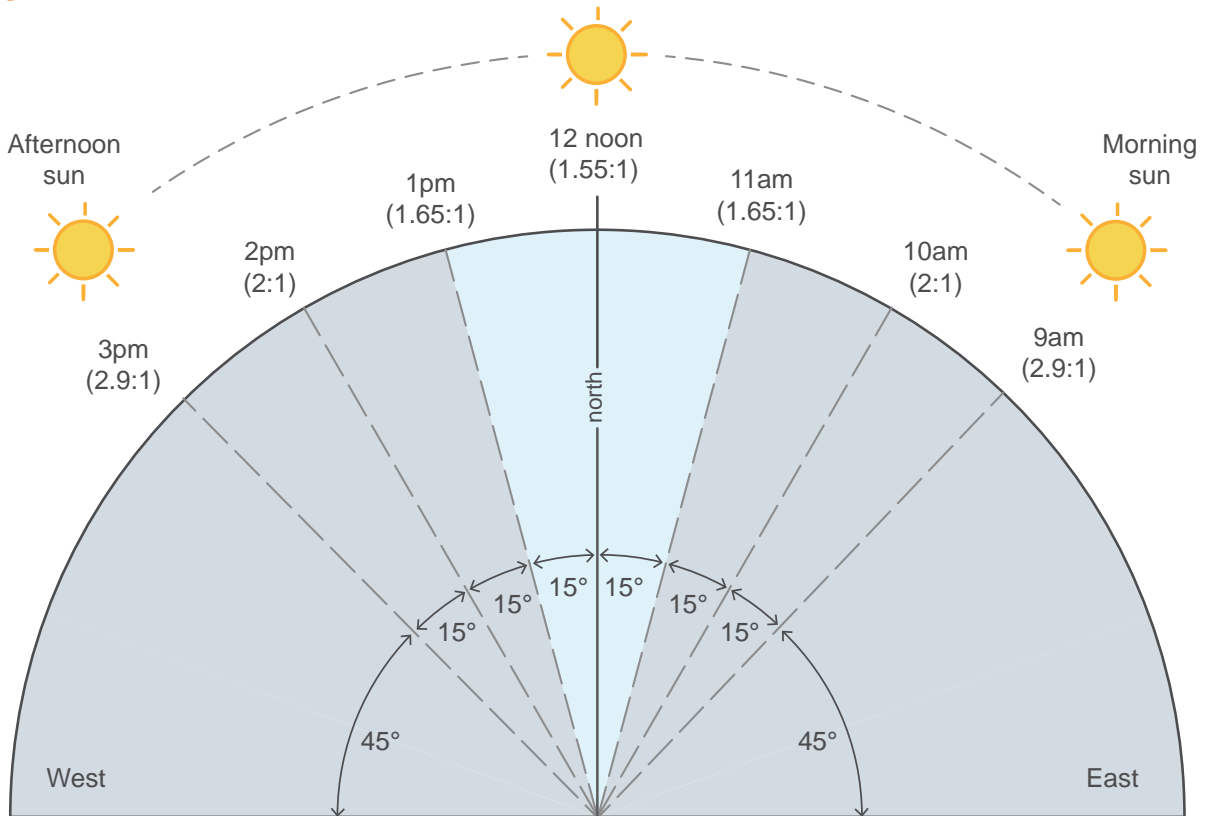

Based on Sydney coordinates
33° South 151.20° East +10 GMT for winter solstice at 21 June

Sun altitude ratios

The ratios below can be used to determine how far sunlight extends into apartments at a given time of day, according to the ratios indicated on the sunlight access tool above

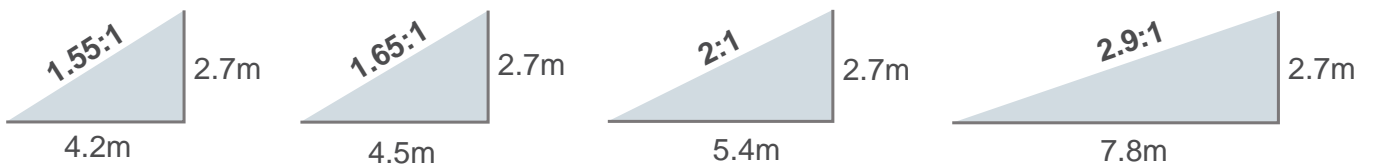
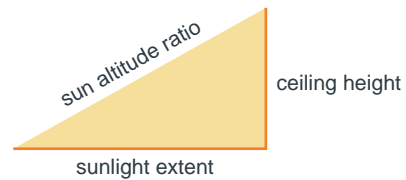

Glossary

Acoustic privacy

a measure of sound insulation between apartments, between apartments and communal areas, and between external and internal spaces

Adaptable housing

housing that is designed and built to accommodate future changes to suit occupants with mobility impairment or life cycle needs

Adaptive reuse

the conversion of an existing building or structure from one use to another, or from one configuration to another

Amenity

the 'liveability', comfort or quality of a place which makes it pleasant and agreeable to be in for individuals and the community. Amenity is important in the public, communal and private domains and includes the enjoyment of sunlight, views, privacy and quiet. It also includes protection from pollution and odours

Aircraft noise

aircraft noise is identified as contours on the Australian Noise Exposure Forecast (ANEF) Map. The higher the ANEF contour value, the greater the exposure to aircraft noise

Articulation zone

an area in front of the building line that may contain porticos, balconies, bay windows, decks, patios, pergolas, terraces, verandahs, window box treatments, window bays, awnings and sun shading features

Attached dwelling

as defined in the *Standard Instrument - Principal Local Environmental Plan*

Bay window

window element which projects a short way past the face of the building. It can have windows on the return walls and sometimes incorporates a seat

BCA

Building Code of Australia

Building line

the predominant line formed by the main external face of the building. Balconies or bay window projections may or may not be included depending on desired streetscape

Building height

as defined in the *Standard Instrument - Principal Local Environmental Plan*

Building depth

is the overall cross section dimension of a building envelope. It includes the internal floor plate, external walls, balconies, external circulation and articulation such as recesses and steps in plan and section

Business zones

land identified on a Land Zoning Map within a local environmental plan as a B1 Neighbourhood Centre, B2 Local Centre, B3 Commercial Core, B4 Mixed Use, B5 Business Development, B6 Enterprise Corridor, B7 Business Park or B8 Metropolitan Centre zone

Note: residential apartment development may not be permissible or appropriate in all Business zones

Busy road or rail line

as defined in *State Environmental Planning Policy (Infrastructure) 2007* and *Development Near Rail Corridors and Busy Roads – Interim Guideline*

Cadastre

the current subdivisional pattern of a locality on the ground e.g. boundaries, roads, waterways, parcel identifiers and names

Clerestory

high level windows that can be part of a wall above a lower roof

Communal open space

outdoor space located within the site at ground level or on a structure that is within common ownership and for the recreational use of residents of the development. Communal open space may be accessible to residents only, or to the public

Core

vertical circulation (lift and/or stairs) within a building. A single core may include multiple lifts serving the same floor area

Corner apartment

cross ventilating apartments on one level with aspects at least 90 degrees apart. Corner apartments are commonly located on the outermost corners of buildings

Cornice

decorative horizontal moulding at the top of a building which 'crowns' or finishes the external facade

Courtyard

communal space at ground level or on a structure (podium or roof) that is open to the sky, formed by the building and enclosed on 3 or more sides

Cross-over apartment

cross ventilating apartment with two opposite aspects and with a change in level between one side of the building and the other

Cross-through apartment

cross ventilating apartment on one level with two opposite aspects

Datum point or datum line

a significant point or line in space established by the existing or desired context, often defined as an Australian Height Datum. For example, the top of significant trees or the cornice of a heritage building

Daylight

consists of both skylight (diffuse light from the sky) and sunlight (direct beam radiation from the sun). Daylight changes with the time of day, season and weather conditions

Deep soil zone

area of soil within a development that are unimpeded by buildings or structures above and below ground and have a minimum dimension of 6m. Deep soil zones exclude basement car parks, services, swimming pools, tennis courts and impervious surfaces including car parks, driveways and roof areas

Dense urban area

an area where the permitted floor space ratio for development under a local environmental plan is 2.5:1 or greater

Director-General's Design Excellence Guidelines

the Design Excellence Guidelines issued by the Director-General in October 2010

Dual aspect apartment

cross ventilating apartments which have at least two major external walls facing in different directions, including corner, cross-over and cross-through apartments

Dual key apartment

an apartment with a common internal corridor and lockable doors to sections within the apartment so that it is able to be separated into 2 independent units. Under the BCA, dual key apartments are regarded as two sole occupancy units. They are also considered as two units when calculating apartment mix

Effective Openable Area (EOA)

the minimum area of clear opening of a window that can take part in providing natural ventilation. The effective openable area of a sliding or hung sash window can be measured in elevation. Hinged windows such as casement, awning and hopper windows may measure the diagonal plane from the sash to the jamb and add the triangles at either end up to a total area of the window opening in the wall. Obstructions within 2m of a window reduce the effective openable area as measured in elevation. Fly screens and security screens will reduce the effective openable area by half

Facade

the external face of a building, generally the principal face, facing a public street or space

Floor Space Ratio

as defined in the *Standard Instrument - Principal Local Environmental Plan*

Gallery access

an external corridor, generally single loaded, which provides access to individual apartments along its length

Glass line

inside face of windows on the external walls of a building

Guide to Traffic Generating Developments

Guide to Traffic Generating Developments, published by Roads and Maritime Services (formerly RTA) and available on its' website

Green roof

a roof surface that supports the growth of vegetation, comprised of a waterproofing membrane, drainage layer, organic growing medium (soil) and vegetation. Green roofs can be classified as either extensive or intensive, depending on the depth of substrate used and the level of maintenance required. Intensive green roofs are generally greater than 300mm deep and are designed as accessible landscape spaces with pathways and other features. Extensive green roofs are generally less than 300mm deep and are generally not trafficable

Green wall

a wall with fixtures to facilitate climbing plants. It can also be a cladding structure with growing medium to facilitate plant growth

Habitable room

a room used for normal domestic activities, and includes a bedroom, living room, lounge room, music room, television room, kitchen, dining room, sewing room, study, playroom, family room and sunroom; but excludes a bathroom, laundry, water closet, pantry, walk-in wardrobe, corridor, hallway, lobby, photographic darkroom, clothes-drying room, and other spaces of a specialised nature occupied neither frequently nor for extended periods, as defined by the BCA

Juliet balcony

a small projecting balcony, generally ornamental or only large enough for one person standing

Livable Housing Design Guidelines

Livable Housing Design Guidelines, published by Livable Housing Australia and available on its' website

Master bedroom

the main bedroom within an apartment, often the largest with an ensuite bathroom

Mid winter

is 21 June (winter solstice) when the sun is lowest in the sky

Mixed use development

as defined in the *Standard Instrument - Principal Local Environmental Plan*

Multi dwelling housing

as defined in the *Standard Instrument - Principal Local Environmental Plan*

Natural cross ventilation

natural ventilation which allows air to flow between positive pressure on the windward side of the building to the negative pressure on the leeward side of the building providing a greater degree of comfort and amenity for occupants. The connection between these windows must provide a clear, unobstructed air flow path. For an apartment to be considered cross ventilated, the majority of the primary living space and n-1 bedrooms (where n is the number of bedrooms) should be on a ventilation path

Non-habitable room

a space of a specialised nature not occupied frequently or for extended periods, including a bathroom, laundry, water closet, pantry, walk-in wardrobe, corridor, hallway, lobby, photographic darkroom or clothes-drying room, as defined by the BCA

On-grade

on ground level

Open plan

apartment layouts where spaces are not divided into discrete rooms, but are open and connected to allow flexibility of use (typically living, dining, kitchen and study areas)

Operable screening device

sliding, folding or retractable elements on a building designed to provide shade, privacy, and protection from natural elements

Operable walls

walls which can be moved, for example by sliding, folding, or pivoting, to allow for different room configurations or a balcony

Parapet

a horizontal low wall or barrier at the edge of a balcony or roof. Often taken to refer to the decorative element which establishes the street wall height of heritage buildings (see cornice)

Perimeter block

development where buildings generally define the street edge and enclose or partially enclose an area in the middle of the block

Plenum

a duct or chamber, usually with grilles, that air passes through. Plenums of small cross section tend to limit the passage of air and are not equivalent in performance to standard windows

Podium

the base of a building upon which taller (tower) elements are positioned

Potable water

water which conforms to Australian Standards for drinking quality

Primary private open space

the principal area of private open space, usually the largest consolidated area

Private open space

outdoor space located at ground level or on a structure that is within private ownership and provided for the recreational use of residents of the associated apartment

Primary windows

windows to habitable rooms located on the external wall of a buildings; primary windows may be supplemented by windows in courtyards, skylights, notches and along galleries

Principal usable part of communal open space

a consolidated part of the communal open space that is designed as the primary focus of recreational activity and social interaction

Public open space

public land for the purpose of open space and vested in or under the control of a public authority

Residential flat building

as defined in the *Standard Instrument - Principal Local Environmental Plan*

Shop top housing

as defined in the *Standard Instrument - Principal Local Environmental Plan*

Silhouette

a building outline viewed against the sky

Sloping site

a site with a slope of 15% or greater

Small lots

sites with an area of less than 650 square metres

Soffit

the undersurface of a balcony or other projecting building element

Solar access

is the ability of a building to continue to receive direct sunlight without obstruction from other buildings or impediments, not including trees

Stack effect ventilation / solar chimney

air convection resulting from hot air being pushed up and out by colder denser air which is drawn in at a lower level

Street setback

the space along the street frontage between the property boundary and the building. Refer to building line or setback as defined in the *Standard Instrument - Principal Local Environmental Plan*

Studio apartment

an apartment consisting of one habitable room that combines kitchen, living and sleeping space

Sunlight

direct beam radiation from the sun

Sydney Metropolitan Area

the 41 Local Government Areas of Ashfield, Auburn, Bankstown, Blacktown, Blue Mountains, Botany, Burwood, Canada Bay, Camden, Campbelltown, Canterbury, Fairfield, Hawkesbury, Holroyd, Hornsby, Hunters Hill, Hurstville, Kogarah, Ku-Ring-Gai, Lane Cove, Leichhardt, Liverpool, Manly, Marrickville, Mosman, North Sydney, Parramatta, Penrith, Pittwater, Randwick, Rockdale, Ryde, Strathfield, Sutherland, Sydney, The Hills, Warringah, Waverley, Willoughby, Wollondilly and Woollahra

Terrace

an outdoor area, usually paved and unroofed, that is connected to an apartment and accessible from at least one room. May be on-grade or on a structure (podium or roof)

Universal design

international design philosophy that enables people to carry on living in the same home by ensuring apartments are able to change with the needs of the occupant

Wintergarden

an enclosed balcony, typically glazed and can be used to minimise noise impacts along busy roads, railway lines and from aircraft noise

Ziggurat

having the form of a terraced structure with successive receding storeys

