



# LEP practice note

## PLANNING SYSTEM

### Local Planning

Ref No.	PN 11-003
Issued	10 March 2011 (supersedes and replaces PN06-003)
Related	LEP PN 11-001; 11-002; PS 11-011

# Preparing LEPs using the Standard Instrument: definitions

The purpose of this practice note is to provide a general overview of the definitions used in the Standard Instrument (Local Environmental Plans) Order 2006 after the 2011 amendments. It should be noted that the explanatory material set out in this practice note is for information purposes only and does not comprise a legal interpretation of any of the definitions in the Standard Instrument.

## Introduction

The Standard Instrument for preparing local environmental plans (LEPs) includes a Dictionary of standard definitions relating to land uses and other terms relevant to the interpretation and application of LEPs.

This means that all LEPs across NSW will soon use the same planning language, including the same definitions for developments such as 'business premises', 'industry' and 'shops'.

The Dictionary is a mandatory provision and will be included in its entirety in all LEPs. To maintain consistency in planning language across the State, councils are not able to alter the standard definitions or directly add definitions to the Dictionary.

Definitions are divided into terms that describe land uses or activities that may be included in Land Use Tables ('land use terms'), and 'explanatory terms' which describe technical, administrative or other land uses that are important to the interpretation of LEPs, but which are not to be included in the Land Use Tables.

However all definitions will appear together in alphabetical order as part of a single Dictionary in each council's LEP.

## Land use terms

Approximately half of the standard definitions can be included in the Land Use Table, e.g. 'dwelling house,' 'restaurant or café,' 'hospital' and 'horticulture.' These are the terms used to describe development that is permitted or prohibited in the different zones used by councils.

Direction 5 of the Land Use Table contains a list of all types of development ('land use terms') that can be included in Land Use Tables. For ease of reference, this list is included in Attachment 1 of this practice note.

## Group terms

The Dictionary includes a number of 'groups' of land use terms that are broadly related by type of use.

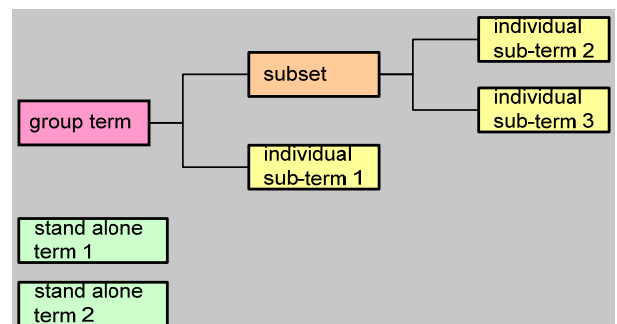

These land uses are included in a 'group term' definition. The intent of these 'group terms' is to minimise the length of Land Use Tables by

enabling LEP Land Use Tables or other provisions to easily refer to a number of land uses without needing to list them individually.

Each group term definition lists the uses it covers (and in some instances, uses it does not cover). For example:

**industry** means any of the following:

- (a) general industry,
  - (b) heavy industry,
  - (c) light industry,
- but does not include:
- (d) rural industry, or
  - (e) extractive industry, or
  - (f) mining.

For example if the term 'industry' is used in the Land Use Tables, it includes 'general industry', 'heavy industry' and 'light industry'. If the term 'rural industry' is used, it includes all types of rural industrial land uses, avoiding the need to specifically list 'agricultural produce industry', 'livestock processing industry', 'sawmill or log processing works' etc.

Group terms are as follows:

- agriculture
- air transport facility
- commercial premises
- educational establishment
- health services facility
- heavy industrial storage premises
- industry
- residential accommodation
- rural industry
- sewerage system
- signage
- storage premises
- tourist and visitor accommodation
- waste or resource management facility
- water supply system.

Some defined land uses need to be read in the context of the group term to understand their full meaning. For example, a 'market' falls under the group term 'retail premises' as it specifically refers to that term in its notation:

**market** means an open-air area, or an existing building, that is used for the purpose of selling, exposing or offering goods, merchandise or materials for sale by independent stall holders, and includes temporary structures and existing permanent structures used for that purpose on an intermittent or occasional basis.

**Note.** A market is a type of retail premises (see the definition of that term in this Dictionary).

Retail premises are in turn defined as:

**retail premises** means a building or place used for the purpose of selling items by retail, or hiring or displaying items for the purpose of selling them or hiring them out, whether the items are goods or materials (or whether also sold by wholesale), and includes any of the following;

- (a) bulky goods premises,
  - (b) cellar door premises,
  - (c) food and drink premises,
  - (d) garden centres,
  - (e) hardware and building supplies,
  - (f) kiosks,
  - (g) landscaping material supplies,
  - (h) markets,
  - (i) plant nurseries,
  - (j) roadside stalls,
  - (k) rural supplies,
  - (l) shops,
  - (m) timber yards,
  - (n) vehicle sales or hire premises,
- but does not include a highway service centre, service station, industrial retail outlet or restricted premises.

**Note.** Retail premises are a type of commercial premises (see the definition of that term in this Dictionary).

Therefore, to be defined as a 'market,' the proposal must satisfy the criteria in *both* definitions. This ensures that there is consistency in definitions relating to retail land uses, and avoids the need for repetition in each of the defined individual retail terms.

Some group terms also contain one or more 'subset terms' that themselves cover other defined land use terms. For example, the term 'food and drink premises' (which falls under the group term 'commercial premises' and its subset 'retail premises') includes the defined terms 'restaurant or cafes', 'take away food and drink premises' and 'pub':

**food and drink premises** means premises that are used for the preparation and retail sale of food or drink for immediate consumption on or off the premises, and includes any of the following:

- (a) a restaurant or cafe,
- (b) take away food premises,
- (c) a pub.

**Note.** Food and drink premises are a type of retail premises (see the definition of that term in this Dictionary).

Attached for information purposes are diagrams that show the general relationships between land use terms associated with each group term (Attachment 2). These diagrams are not a legal

interpretation of the definitions, but rather an information tool to assist council planners in developing their LEPs. The exact definition in the Standard Instrument must always be used when interpreting any defined term.

### Group terms and Clause 2.3(3)

Clause 2.3(3) of the Standard Instrument states that, with respect to the Land Use Table for zones:

- (b) a reference to a type of building or other thing does not include (despite any definition in this Plan) a reference to a type of building or other thing referred to separately in the Land Use Table in relation to the same zone.

Councils should also be aware that this provision relates only to types of buildings or things that are specifically referred to in the Land Use Table **in the same zone**. It means that a group term may cover a different range of land uses from zone to zone.

Councils should be mindful that this provision cannot be used to vary the mandated land uses. For example, where 'tourist and visitor accommodation' is mandated as permitted with consent in a zone, an LEP cannot list any component of the group term e.g. 'serviced apartments' as prohibited development in that zone.

### Using terms to make zones 'open' or 'closed'

An **open zone** is one where a broad variety of land use can be considered allowing greater flexibility and minimizing the need to undertake 'spot rezonings'.

A **closed zone** is one where the diversity of land uses is more restrictive, meaning development types are chosen primarily from only one or two key 'group' terms.

See LEP PN 11-002 *Preparing LEPs using the Standard Instrument: standard zones* for further information on which zones should generally be open and which should be closed.

### Ancillary uses

A use is ancillary to another use if it is incidental or subservient. If a use is ancillary, then it is to be characterised as being for the dominant purpose.

Some definitions refer to examples of ancillary services or facilities to assist readers. For instance, the definition of 'service station' refers to the ancillary sale by retail of spare parts and accessories for motor vehicles.

Ancillary uses don't need to be separately included in the Land Use Table.

## Terms not to be used in Land Use Tables

The Standard Instrument contains a number of miscellaneous terms that are essential to the operation and clarity of the Standard Instrument and LEPs. These terms are not to be used in Land Use Tables. These include:

- administrative terms (e.g. 'the Act')
- environmental and hazard terms (e.g. 'biodiversity' and 'bush fire prone land')
- heritage terms (e.g. 'heritage conservation area')
- maps (e.g. 'Land Application Map')
- measurement terms (e.g. 'building height')
- waterways (e.g. 'coastal lake'), and
- other miscellaneous terms to assist in interpretation of clauses or land use definitions (e.g. 'affordable housing' and 'basement').
- Certain SEPP terms (e.g. 'canal estate development').

For information purposes, a list of these terms is set out in Attachment 3.

## Terms not defined in the Dictionary

Many terms used in the Standard Instrument are not separately defined in the Dictionary. In these cases, the ordinary meaning of the word is to be used, which can usually be ascertained by referring to the Macquarie Dictionary.

Some definitions also refer to land uses that are not specifically defined. For example, the definition of an 'information and education facility' refers to 'library', 'art gallery' and 'museum' which are not defined in the Dictionary. These terms have their common meanings, and are included to clarify beyond doubt that these activities are a form of 'information and education facility'.

## Terms requiring "inserted" information

A small number of definitions require councils to insert information such as the name of the local government area. Examples include the definitions of 'Heritage Map' and 'Lot Size Map'. Councils are to replace the words in [*bracketed italics*] with the relevant information.

## Additional standard definitions

To maintain consistency across the State, LEPs may not alter the standard definitions or directly add definitions to the Dictionary. However councils may suggest new terms to the Department of Planning to be included in the Dictionary for all councils to use. The reasons why a definition is required should be clearly articulated.

If there is sufficient justification that the existing standard definitions will not adequately address a particular matter and that the common dictionary meaning of the word is insufficient, the definition may be added in a future amendment to the Standard Instrument. Until the term is added to the dictionary, it cannot be included in the Land Use Tables.

### Defining terms in local provisions

If a council considers it desirable to clarify the interpretation of a term (other than a term defined in the Dictionary) that is used in a local provision by including a specific definition, then the council should discuss the matter with the Department as part of the preliminary discussions on the draft plan.

Depending on the circumstances, it may be considered appropriate to define a term within the locally prepared clause. However, in most instances it will usually be possible to draft a local provision using common language terms. Terms in the Dictionary are not affected by local provision definitions.

### Key changes in the 2011 Amendments

The Standard Instrument (Local Environmental Plans) Amendment Order 2011 was published on 25 February 2011. It amends the Standard Instrument (Local Environmental Plans) Order 2006 including the Standard Instrument—Principal Local Environmental Plan (the standard LEP).

The primary objective of the amending order is to improve the efficiency of delivery of standard LEPs. It aims to ensure existing land use terms do not overlap across definitions and the relationship between definitions is clearer, through the inclusion of new terms, amendments to existing terms, and cross referencing the group term/sub-term relationships.

Key changes to dictionary terms are identified in Attachment 4. These include:

#### Commercial related terms

- **commercial premises** is a new group term including 'retail,' 'office' and 'business premises.' This provides an efficient term to describe the mix of uses in centres;
- **retail premises** has now been amended to specifically list retail premises including 'bulky goods premises,' 'cellar door premises,' 'food and drink premises,' 'garden centres,' 'hardware and building supplies,' 'kiosks,' 'landscaping material supplies,' 'markets,' 'plant nurseries,' 'roadside stalls,' 'rural supplies,' 'shops,' 'timber yards' and 'vehicle sales or hire premises';
- **shop** now refers to the broader term 'merchandise' rather than 'general

merchandise,' and the hiring of this merchandise. It also includes a 'neighbourhood shop';

- **neighbourhood shop** has been amended to clarify that general (as opposed to specialist) merchandise can be sold where this provides for the day-to-day needs of people in the area. It is also confirmed as a type of 'shop.'

#### Landscaping related terms

New terms have been introduced to separate components previously covered in the old definition '*landscape and garden supplies*.' This enables uses to be considered individually in different zones providing more flexibility for councils and proponents.

- **garden centre** covers the sale of plants, garden and landscaping supplies and equipment. It also includes ancillary uses such as a 'restaurant or café,' and the sale of fresh produce, pets and pet supplies, outdoor furniture and furnishings, barbeques, shading and awnings, pools, spas and associated supplies, and items associated with the construction and maintenance of outdoor areas;
- **plant nursery** covers the growing and retail sale of plants (whether or not also by wholesale), and may also include the sale of landscaping supplies and equipment and storage of these items;
- **horticulture** covers the growing and wholesaling of plants for gardens or landscaping;
- **landscaping material supplies** covers the storage and sale of landscaping supplies such as soil, gravel, potting mix, mulch, sand, railway sleepers, screenings, rock and the like.

#### Building related terms

The previous '*timber and building supplies*' definition has been split in two. This enables more flexibility in the location of timber yards and hardware shops.

- **hardware and building supplies** covers the sale or hire of goods or materials, such as household fixtures, timber, tools, paint, wallpaper, plumbing supplies and the like, that are used in the construction and maintenance of buildings and adjacent outdoor areas;
- **timber yard** is a stand alone land use enabling councils to consider permitting it in certain industrial or other zones if suited. It covers the sale of timber, wood fibre boards or similar timber products. It may include the cutting of such timber, boards or products to order and the sale of hardware, paint, tools and materials. It is a 'retail premises';
- **sawmill or log processing works** covers the handling, cutting, chipping, pulping or otherwise processing of logs, baulks, branches or stumps, principally derived from surrounding

districts, into timber or other products derived from wood. It is a 'rural industry.'

### Industry related terms

To provide greater certainty, there was a need to clarify the different types of 'industry.' The previous definition of '*industry*' which defined the processes and activities undertaken by any industry has now been redefined as the interpretative term ***industrial activity***.

'Industry' is now a group term with 'general industry' introduced to describe industry which is not a 'light industry' or 'heavy industry.' The following changes have been made to the industry related terms:

- ***industry*** is a group term which has been revised to clarify that it includes 'light industry,' 'general industry' and 'heavy industry,' but does not include 'rural' or 'extractive industries' or 'mining';
- ***general industry*** is to be used for industrial uses that aren't considered to be 'light' or 'heavy industry';
- ***light industry*** now includes 'high technology industry' and 'home industries';
- ***industrial training facility*** provides for vocational training associated with 'industry,' 'rural industry,' 'extractive industry' and 'mining';
- ***industrial retail outlet*** provides for display and sale of goods manufactured on site including 'industries' and 'rural industries'.

### Further information

A copy of this practice note, the Standard Instrument, and other specific practice notes and planning circulars on using the Standard Instrument, can be accessed on the Department's website

<http://www.planning.nsw.gov.au/LocalPlanning/tabid/246/language/en-US/Default.aspx>

An updated version of the standard instrument is available on the NSW Parliamentary Counsel's office website: [www.legislation.nsw.gov.au](http://www.legislation.nsw.gov.au) under 'Browse A-Z In Force'.

If you have further enquiries, please phone the Planning Information Centre 02 9228 6333 or email [information@planning.nsw.gov.au](mailto:information@planning.nsw.gov.au).

### List of attachments

Attachment 1 – Direction 5 of the Land Use Table  
Attachment 2 – General relationship between land use terms  
Attachment 3 – Defined terms not to be used in Land Use Table  
Attachment 4 – Key changes to dictionary terms made through the SI Amendment Order 2011

### Authorised by:

**Sam Haddad**  
**Director General**

---

Important note: This practice note does not constitute legal advice. Users are advised to seek professional advice and refer to the relevant legislation, as necessary, before taking action in relation to any matters covered by this practice note.

© State of New South Wales through the Department of Planning [www.planning.nsw.gov.au](http://www.planning.nsw.gov.au)

Disclaimer: While every reasonable effort has been made to ensure that this document is correct at the time of publication, the State of New South Wales, its agencies and employees, disclaim any and all liability to any person in respect of anything or the consequences of anything done or omitted to be done in reliance upon the whole or any part of this document.

## ATTACHMENT 1:

### Direction 5 of the Land Use Table

Only the following types of development may be included in the Land Use Table:

Advertising structures; Agricultural produce industries; Agriculture; Air transport facilities; Airports; Airstrips; Amusement centres; Animal boarding or training establishments; Aquaculture; Attached dwellings

Backpackers' accommodation; Bed and breakfast accommodation; Bee keeping; Biosolids treatment facilities; Boarding houses; Boat launching ramps; Boat building and repair facilities; Boat sheds; Building identification signs; Bulky goods premises; Business identification signs; Business premises

Camping grounds; Car parks; Caravan parks; Cellar door premises; Cemeteries; Charter and tourism boating facilities; Child care centres; Commercial premises; Community facilities; Correctional centres; Crematoria

Dairies (pasture-based); Dairies (restricted); Depots; Dual occupancies; Dual occupancies (attached); Dual occupancies (detached); Dwelling houses

Eco-tourist facilities; Educational establishments; Electricity generating works; Emergency services facilities; Entertainment facilities; Environmental facilities; Environmental protection works; Exhibition homes; Exhibition villages; Extensive agriculture; Extractive industries

Farm buildings; Farm stay accommodation; Feedlots; Flood mitigation works; Food and drink premises; Forestry; Freight transport facilities; Function centres; Funeral homes

Garden centres; General industries; Group homes; Group homes (permanent) or permanent group homes; Group homes (transitional) or transitional group homes

Hardware and building supplies; Hazardous industries; Hazardous storage establishments; Health consulting rooms; Health services facilities; Heavy industrial storage establishments; Heavy industries; Helipads; Heliports; High technology industries; Highway service centres; Home-based child care; Home businesses; Home industries; Home occupations; Home occupations (sex services); Horticulture; Hospitals; Hostels; Hotel or motel accommodation

Industrial retail outlets; Industrial training facilities; Industries; Information and education facilities; Intensive livestock agriculture; Intensive plant agriculture

Jetties

Kiosks

Landscaping material supplies; Light industries; Liquid fuel depots; Livestock processing industries

Marinas; Markets; Medical centres; Mooring pens; Moorings; Mortuaries; Multi dwelling housing

Neighbourhood shops

Offensive industries; Offensive storage establishments; Office premises; Open cut mining

Passenger transport facilities; Places of public worship; Plant nurseries; Port facilities; Public administration buildings; Pubs

Recreation areas; Recreation facilities (indoor); Recreation facilities (major); Recreation facilities (outdoor); Registered clubs; Research stations; Residential accommodation; Residential care facilities; Residential flat buildings; Resource recovery facilities; Respite day care centres; Restaurants or cafes; Restricted premises; Retail premises; Roads; Roadside stalls; Rural industries; Rural supplies; Rural workers' dwellings

Sawmill or log processing works; Schools; Secondary dwellings; Self-storage units; Semi-detached dwellings; Seniors housing; Service stations; Serviced apartments; Sewage reticulation systems; Sewage treatment plants; Sewerage systems; Sex services premises; Shops; Shop top housing; Signage; Stock and sale yards; Storage premises

Take away food and drink premises; Timber yards; Tourist and visitor accommodation; Transport depots; Truck depots; Turf farming

Vehicle body repair workshops; Vehicle repair stations; Vehicle sales or hire premises; Veterinary hospitals; Viticulture

Warehouse or distribution centres; Waste disposal facilities; Waste or resource management facilities; Waste or resource transfer stations; Water recreation structures; Water recycling facilities; Water reticulation systems; Water storage facilities; Water supply systems; Water treatment facilities; Wharf or boating facilities; Wholesale supplies

**ATTACHMENT 2:**

**General relationship between land use terms**

<b>INDEX:</b>	<b>Page</b>
agriculture.....	9
air transport facility.....	17
commercial premises.....	12, 13
educational establishment .....	18
health services facility.....	18
heavy industrial storage premises .....	15
industry.....	14
residential accommodation.....	10
rural industry.....	14
sewerage system.....	16
signage.....	19
storage premises .....	15
tourist and visitor accommodation.....	11
waste or resource management facility. ....	16
water supply system.....	16

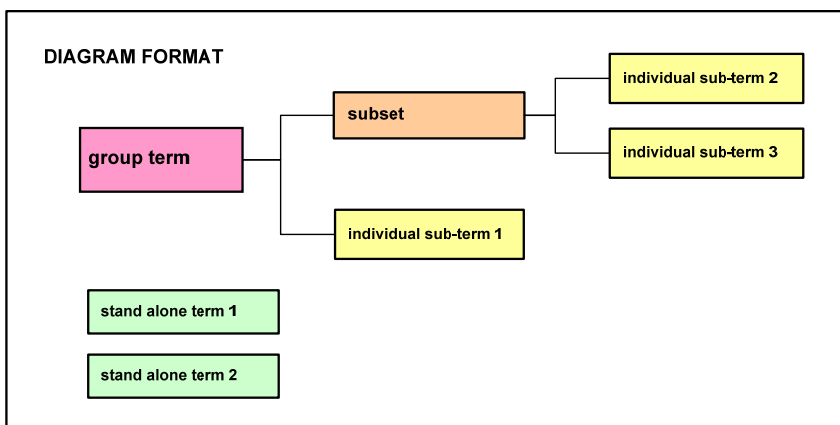
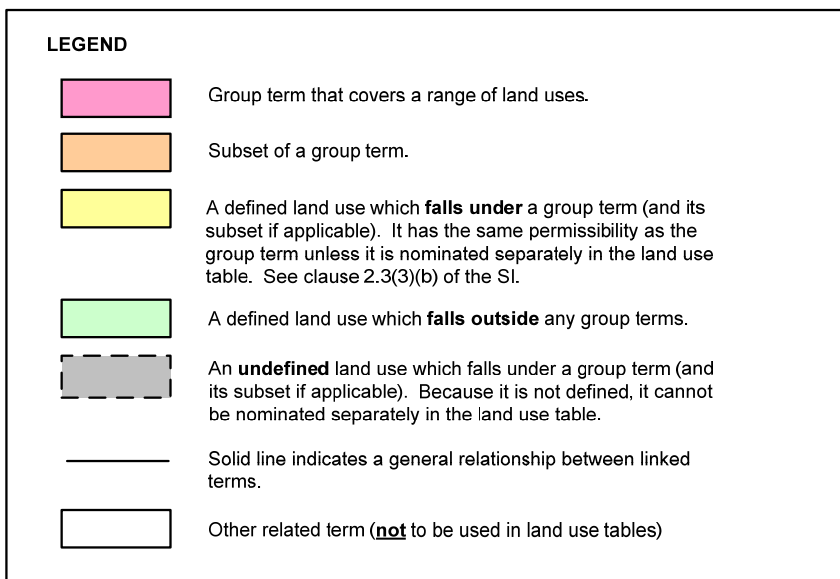



# AGRICULTURE

LAND USE terms WITHIN agriculture group term:

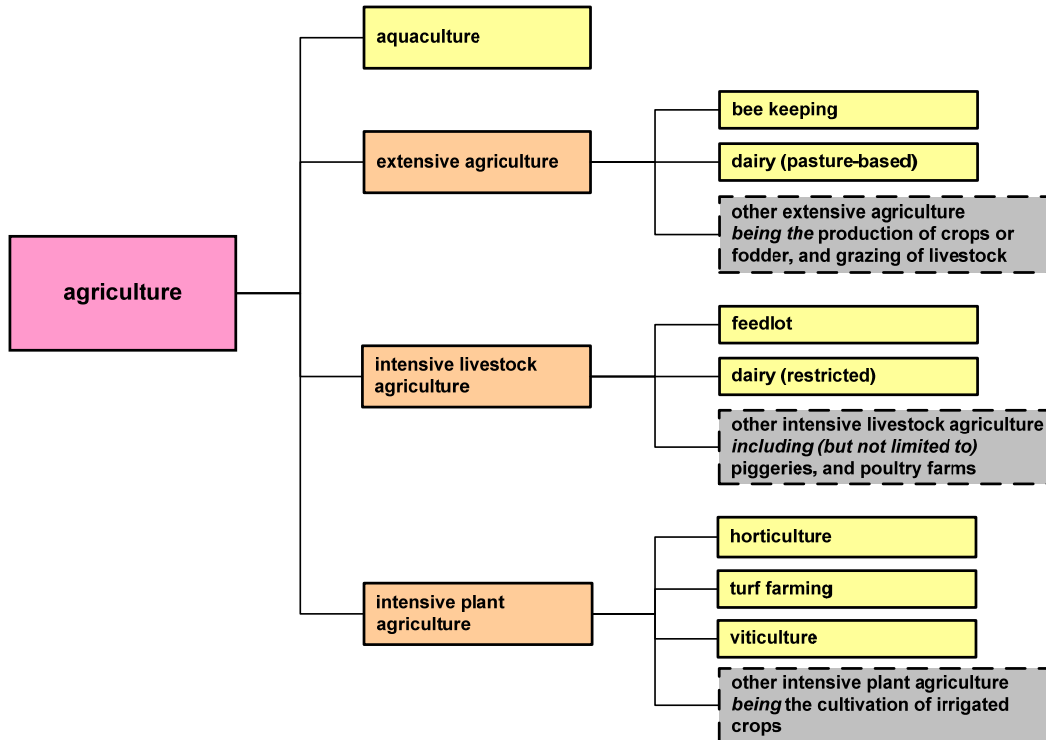

## LAND USE terms OUTSIDE agriculture group term

Examples:

animal boarding or training establishment

farm building

forestry

Any sub-terms WITHIN residential accommodation group term:

Examples:

rural worker's dwelling

Any sub-terms WITHIN tourist and visitor accommodation group term:

Examples:

farm stay accommodation

Any sub-terms WITHIN commercial premises group term:

Examples:

cellar door premises

roadside stall

Any sub-terms WITHIN rural industry group term:

Examples:

agricultural produce industry

livestock processing industry

## Other related terms NOT to be used in LAND USE TABLES

Examples:

restriction facilities

# RESIDENTIAL ACCOMMODATION

LAND USE terms WITHIN residential accommodation group term:

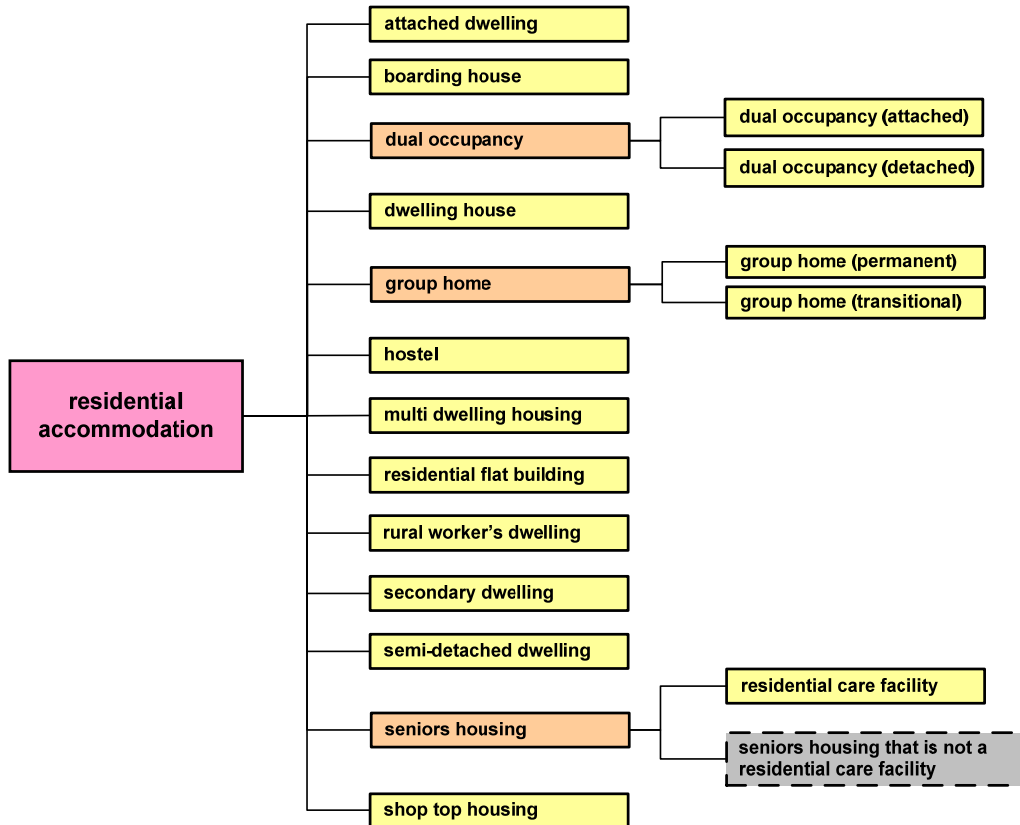

## LAND USE terms OUTSIDE residential accommodation group term

<p>Examples:</p> <ul style="list-style-type: none"> <li>camping ground</li> <li>caravan park</li> <li>exhibition home</li> <li>exhibition village</li> <li>home-based child care</li> </ul>	<p>Any sub-terms WITHIN <b>health services facility</b> group term:</p> <p>Examples:</p> <ul style="list-style-type: none"> <li>health consulting rooms</li> <li>home business</li> <li>home occupation</li> <li>home occupation (sex services)</li> </ul>	<p>Any sub-terms WITHIN <b>industry</b> group term:</p> <p>Examples:</p> <ul style="list-style-type: none"> <li>home industry</li> </ul>
<p>Any sub-terms WITHIN <b>tourist and visitor accommodation</b> group term:</p> <p>Examples:</p> <ul style="list-style-type: none"> <li>bed and breakfast accommodation</li> <li>serviced apartment</li> </ul>		

## Other related terms NOT to be used in LAND USE TABLES

Examples:

- affordable housing
- dwelling
- mixed use development
- moveable dwelling

# TOURIST AND VISITOR ACCOMMODATION

LAND USE terms WITHIN **tourist and visitor accommodation** group term:

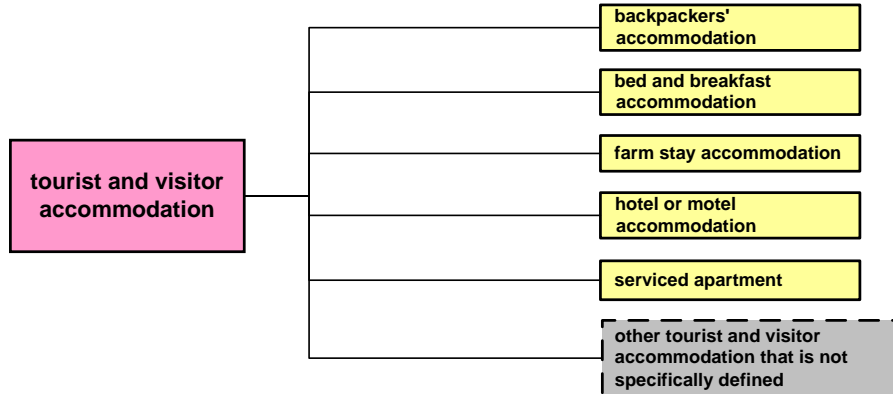

**LAND USE terms OUTSIDE **tourist and visitor accommodation** group term**

Examples:

- camping ground
- caravan park
- eco-tourist facility

Any sub-terms WITHIN **residential accommodation** group term:

Examples:

- boarding house
- dwelling house
- residential flat building

Other related terms NOT to be used in LAND USE TABLES

Examples:

- mixed use development

# COMMERCIAL PREMISES

LAND USE terms WITHIN commercial premises group term:

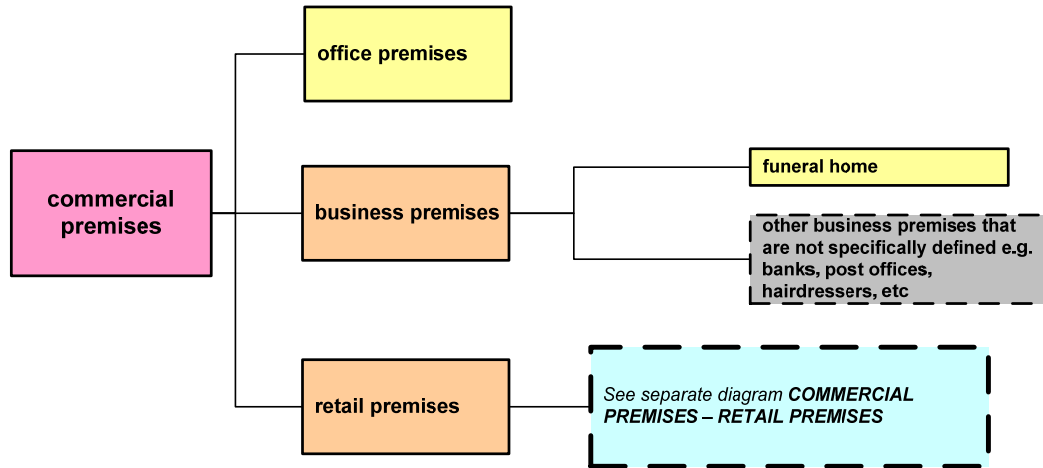

## LAND USE terms OUTSIDE commercial premises group term

Examples:

amusement centre

home occupation

registered club

vehicle body repair workshop

animal boarding or training establishments

home occupation (sex services)

restricted premises

vehicle repair station

boat building or repair facility

industrial retail outlet

service station

veterinary hospital

entertainment facility

industrial training facility

sex services premises

wholesale supplies

function centre

Any sub-terms WITHIN health services facility group term:

Examples:

medical centre

health consulting rooms

highway service centre

home-based child care

home business

Other related terms NOT to be used in LAND USE TABLES

Examples:

brothel

mixed use development

# COMMERCIAL PREMISES – RETAIL

LAND USE terms WITHIN commercial premises group term:

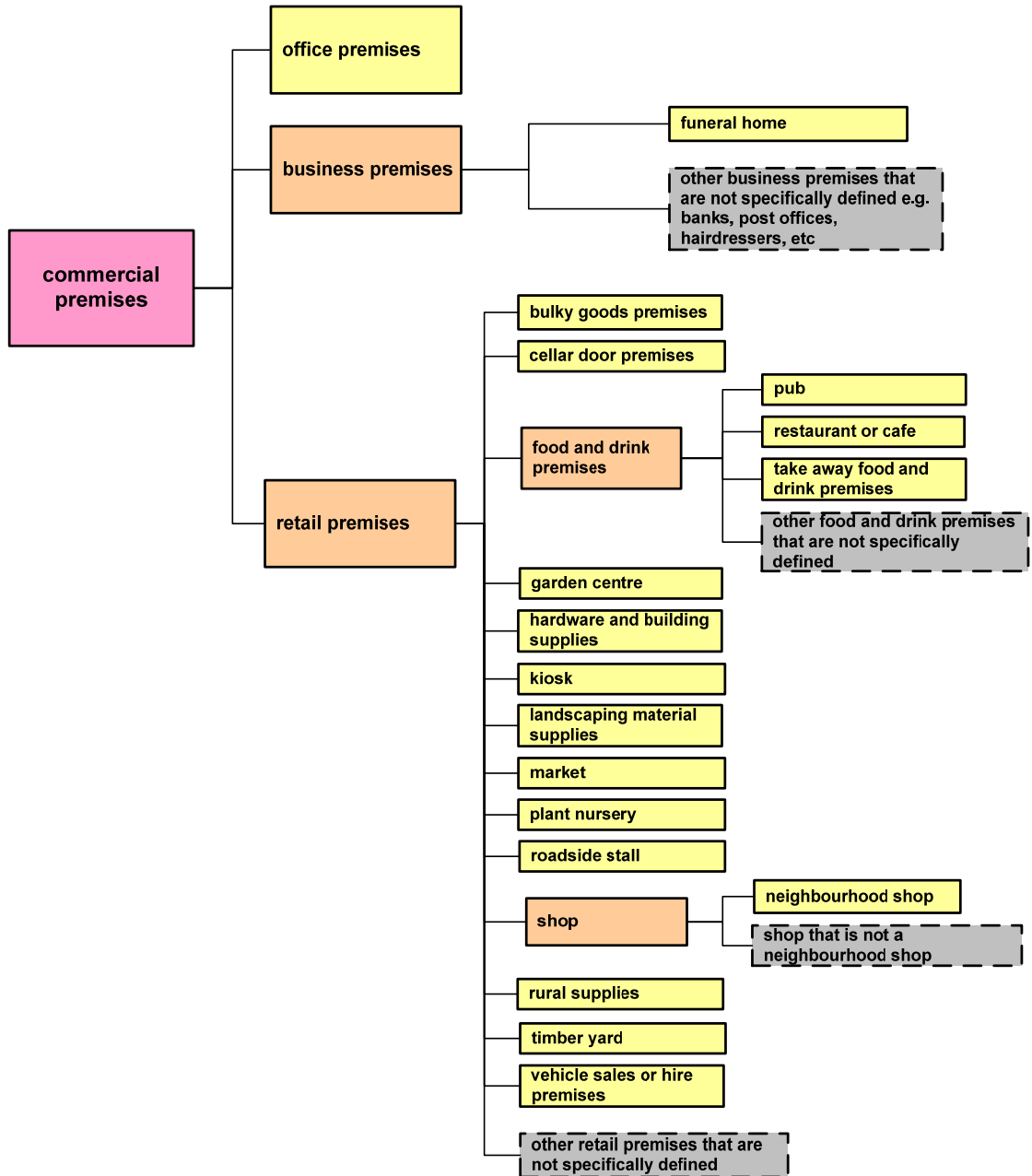

## LAND USE terms OUTSIDE commercial premises group term

Examples:

highway service centre

industrial retail outlet

restricted premises

service station

# INDUSTRY & RURAL INDUSTRY

LAND USE terms WITHIN industry group term:

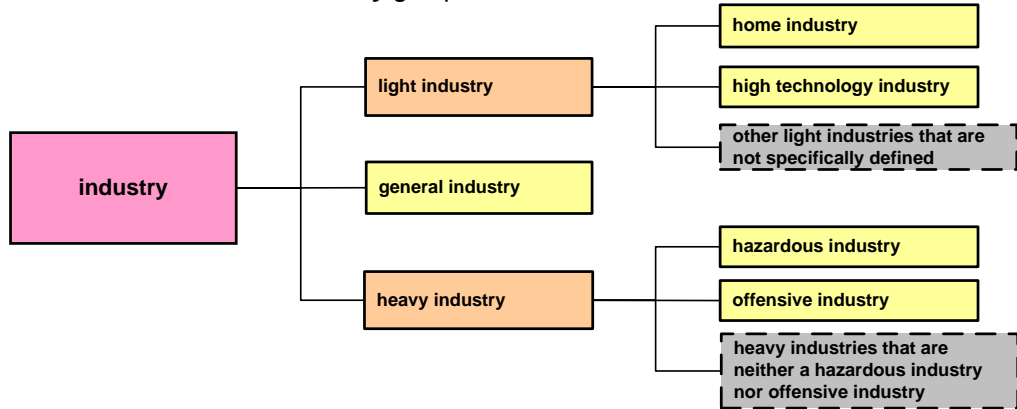

LAND USE terms WITHIN rural industry group term:

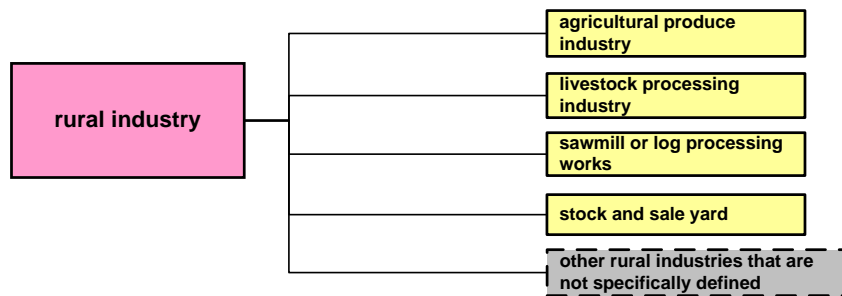

**LAND USE terms OUTSIDE BOTH industry & rural industry group terms**

Examples:

boat building or repair facility	industrial training facility	warehouse or distribution centre	wholesale supplies
depot	open cut mining	Miscellaneous related group term: Examples: <div style="display: flex; justify-content: space-around;"> <div style="border: 1px solid black; padding: 5px; background-color: #f8d7da;">storage premises</div> <div style="border: 1px solid black; padding: 5px; background-color: #f8d7da;">heavy industrial storage establishment</div> </div>	
extractive industry	vehicle body repair workshop		
industrial retail outlet	vehicle repair station		

Other related terms NOT to be used in LAND USE TABLES

Examples:

industrial activity	mining	underground mining
---------------------	--------	--------------------

# STORAGE LAND USES

**LAND USE** terms WITHIN **storage premises** group term:

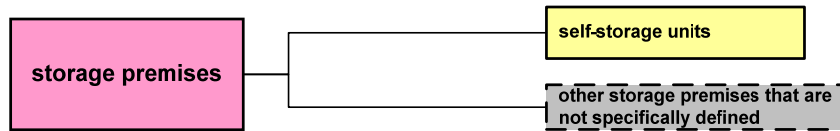

**LAND USE** terms WITHIN **heavy industrial storage establishment** group term:

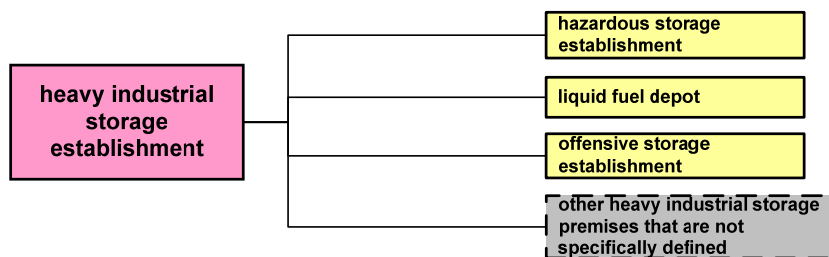

## LAND USE terms OUTSIDE BOTH storage premises & heavy industrial storage establishment group terms

Examples:

depot

warehouse or distribution centre

industrial retail outlet

wholesale supplies

Miscellaneous related group term:

Examples only:

industry

rural industry

# INFRASTRUCTURE – WATER & WASTE

**LAND USE** terms WITHIN **sewerage system** group term:

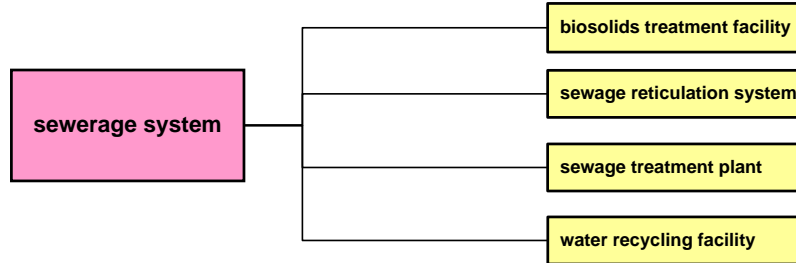

**LAND USE** terms WITHIN **waste or resource management facility** group term:

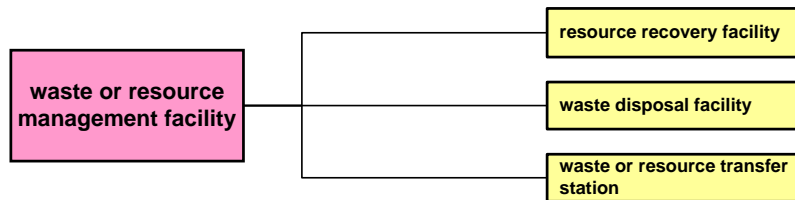

**LAND USE** terms WITHIN **water supply system** group term:

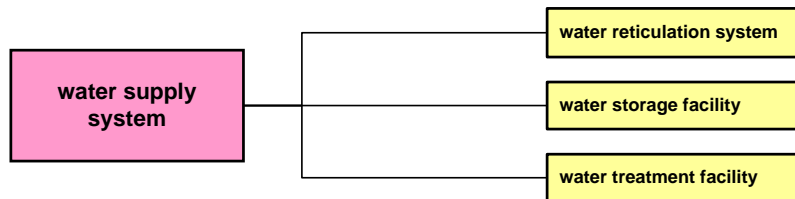

## Other **LAND USE** terms relating to public utility infrastructure

Examples:

electricity generating works

## Other related terms NOT to be used in **LAND USE** TABLES

Examples:

public utility undertaking

telecommunications facility

telecommunications network



# INFRASTRUCTURE – TRANSPORT

**LAND USE** terms WITHIN **air transport facility** group term:

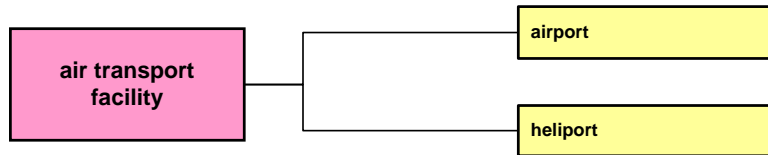

## LAND USE terms OUTSIDE **air transport facility** group term

Examples:

airstrip

helipad

## Other **LAND USE** terms relating to transport infrastructure

Examples:

boat shed

passenger transport facility

transport depot

car park

port facilities

truck depot

freight transport facility

road

wharf or boating facilities

## Other related terms NOT to be used in LAND USE TABLES

Examples:

classified road

navigable waterway

waterbody (artificial)

parking space

public utility undertaking

waterway

# INFRASTRUCTURE – COMMUNITY

**LAND USE** terms WITHIN **educational establishment** group term:

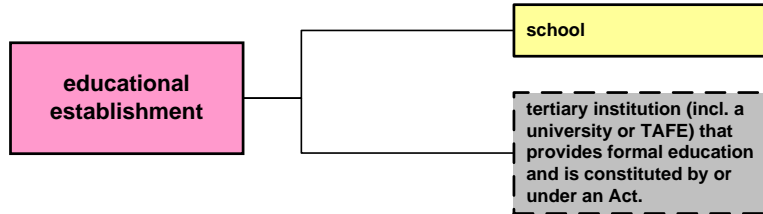

**LAND USE** terms WITHIN **health services facility** group term:

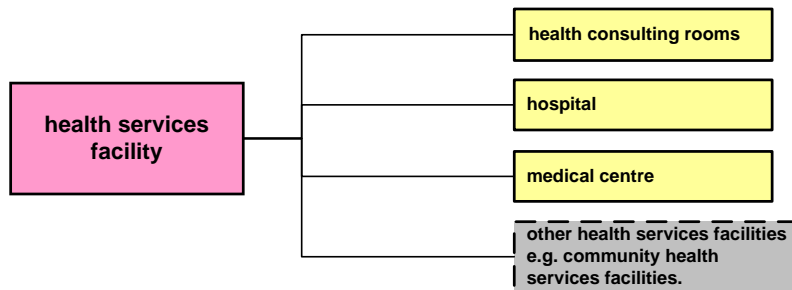

## Other LAND USE terms relating to community infrastructure

Examples:

child care centre

home-based child care

public administration building

community facility

industrial training facility

research station

correctional centre

information and education facility

respite day care centre

emergency services facility

places of public worship

## Other related terms NOT to be used in LAND USE TABLES

Examples:

clearing native vegetation

community land

public reserve

# OTHER MISCELLANEOUS LAND USES

LAND USE terms WITHIN signage group term:

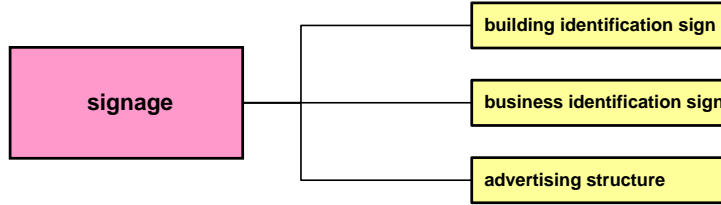

**LAND USE terms relating to recreation**

Examples:

boat launching ramp	jetty	recreation area	water recreation structure
boat shed	marina	recreation facility (indoor)	
charter and tourism boating facility	mooring	recreation facility (major)	
environmental facility	mooring pen	recreation facility (outdoor)	

**Other miscellaneous LAND USE terms**

Examples:

cemetery	environmental protection works	mortuary
crematorium	flood mitigation works	

Other related terms NOT to be used in LAND USE TABLES

Examples:

advertisement	coastal protection works	earthworks	waterbody (artificial)
clearing native vegetation	drainage	ecologically sustainable development	

## ATTACHMENT 3:

### Defined terms not to be used in Land Use Tables

#### Administrative terms

Council  
community land  
Crown reserve  
operational land  
public authority  
public land  
public reserve  
the Act

#### Environment and hazards

acid sulfate soils  
Acid Sulfate Soils Manual  
biodiversity  
biological diversity  
bush fire hazard reduction work  
bush fire prone land  
bush fire risk management plan  
catchment action plan  
clearing native vegetation  
ecologically sustainable development  
extractive material  
fish  
mine subsidence district  
native fauna  
native flora  
native vegetation  
property vegetation plan

#### Heritage

Aboriginal object  
Aboriginal place of heritage significance  
archaeological site  
curtilage (in relation to heritage)  
demolish (in relation to heritage)  
heritage conservation area  
heritage conservation management plan  
heritage impact statement  
heritage item  
heritage management document  
heritage significance  
maintenance (in relation to heritage)  
nominated State heritage item  
relic

#### Maps

Floor Space Ratio Map  
Height of Buildings Map  
Heritage Map  
Land Application Map  
Land Reservation Acquisition Map  
Land Zoning Map

Lot Size Map

#### Measurement

building height  
building line or setback  
floor space ratio  
gross floor area  
ground level (existing)  
ground level (finished)  
ground level (mean)  
Reduced Level (RL)  
site area  
site coverage  
storey

#### Water and Coastal

coastal foreshore  
coastal hazard  
coastal lake  
coastal protection works  
coastal waters of the State  
coastal zone  
estuary  
headland  
mean high water mark  
navigable waterway  
non-potable water  
NSW Coastal Policy  
potable water  
waterbody  
waterbody (artificial)  
waterbody (natural)  
watercourse  
waterway  
wetland

#### Other terms

advertisement  
affordable housing  
attic  
basement  
brothel  
building  
classified road  
drainage  
dwelling  
earthworks  
emergency services organisation  
excavation  
fill  
filming  
health care professional

industrial activity  
landscaped area  
mezzanine  
mixed use development  
moveable dwelling  
parking space  
private open space  
public utility undertaking  
rainwater tank  
restriction facilities  
sex services  
spa pool  
swimming pool  
temporary structure

### SEPP terms

canal estate development  
mine  
mining  
telecommunications facility  
telecommunications network  
underground mining

**Note.** These types of development are regulated by State Environmental Planning Policies.

## ATTACHMENT 4:

### Key changes to dictionary terms made through the SI Amendment Order 2011

The *Standard Instrument (Local Environmental Plans) Amendment Order 2011* was published on 25 February 2011. It amends the *Standard Instrument (Local Environmental Plans) Order 2006* including the *Standard Instrument—Principal Local Environmental Plan (the standard LEP)*.

The primary objective of the amending order is to improve the efficiency of delivery of Standard LEPs and it aims to ensure existing land use terms do not overlap across definitions and the relationship between definitions is clearer, through the inclusion of new terms, amendments to existing terms, and cross referencing the group term/sub-term relationships. Group terms all contain the sub-terms they encompass. Each sub-term now includes a note confirming which group term they are a type of. It has now also been clarified which terms can be used in the Land Use Table and which terms can not (see Direction 5 at the beginning of the Land Use Table).

#### New, renamed and amended definitions

- **Aboriginal place of heritage significance** has been renamed from *place of Aboriginal significance* to cluster related Aboriginal heritage terms in the Dictionary for ease of use;
- **agricultural produce industry** now includes reference to *wineries* in its definition;
- **attached dwelling, dual occupancy, multi dwelling housing, secondary dwelling and semi-detached dwelling** no longer contain the wording '(not being an individual lot in a strata plan or community title scheme)'. This enables councils to approve attached dwellings on such lots if deemed appropriate for their council area. A new optional clause 4.4AA has been included in the Order for councils who wish to retain control over community title lot size for certain residential accommodation;
- **archaeological site** is now the same as the definition in the *Heritage Act*, and no longer makes reference to the Heritage Map or listing in Schedule 5;
- **bed and breakfast accommodation** now includes a reference that this use can only be considered where there is an *existing* dwelling. This is to avoid situations where, for example, a development application is lodged for a *bed and breakfast accommodation* in zones where dwelling houses may no longer be permitted;
- **beekeeping** already exists as part of *extensive agriculture* but is now to be defined as a new stand alone land use, so it can be permitted if appropriate in areas not suited to broader agricultural activities such as in forestry areas;
- **boat building or repair facilities** has been renamed to clarify it covers more than 'repair', by specifically referencing 'boat building';
- **brothel** now provides a note directing readers to the definitions of *home occupation (sex services)* and *sex services premises*;
- **building height (or height of building)** has been amended to be consistent with the Codes SEPP, removing the words 'at any point.' The definition of *ground level (existing)* which *building height* references means the existing level of a site at any point;
- **bulky goods premises** is included in the group term 'retail premises' and now requires applicants to meet *both* parts (a) and (b). It also includes some examples of what might constitute bulky goods including floor and window supplies, swimming pools and equestrian supplies;
- **business premises** now clarifies that it includes a *funeral home* and excludes *entertainment facilities, restricted premises, medical centres* and other land uses;
- **camping ground** exists as part of the definition of *caravan park* but is now to be clearly provided as a stand alone use, so it can be permitted if appropriate in areas of environmental sensitivity where *caravan parks* may not be suitable;
- **cellar door premises** has been amended to change the requirement that *all* of the wine offered for sale is produced in a winery situated on that land or produced predominantly from grapes grown in the local area, to *most* to enable greater flexibility;
- **cemetery** now includes provision for pets and clarifies it can contain an associated building for conducting memorial services;
- **coastal hazard** is included to assist in the application of a new subclause included in Clause 5.5 *Development within the coastal zone*;
- **coastal protection works** is not a Land Use Table term, but is separated from the definition of *environmental protection works* as its permissibility is covered through the Infrastructure SEPP;

- **commercial premises** is a new group term including *retail, office and business premises*;
- **crematorium** clarifies it could contain an associated building for conducting memorial services;
- **dairy (restricted)** has been renamed from restricted dairy in order to cluster related uses in the Dictionary for ease of use. Clarification has also been provided that it is a type of *intensive livestock agriculture*. The term has been renamed wherever it occurs, such as in the definition of *intensive livestock agriculture*;
- **demolish** in relation to heritage matters specifically includes *Aboriginal objects* which previously were considered through the term *heritage item* (now amended);
- **dual occupancy** is a new group term including **dual occupancy (attached)** and **dual occupancy (detached)**. This change confirms that the two types of *dual occupancy* can be separately applied;
- **eco-tourist facility** is a new term that caters for low impact tourist use located in or adjacent to an area with special ecological or cultural features. A number of non-Standard Instrument LEPs contain a similar use;
- **emergency service organisation** is amended to replace *New South Wales Fire Brigades* with *Fire and Rescue NSW* to reflect the change in name of the emergency service organisation. Note that the change in name will also occur in *Clause 5.8 Conversion of Fire Alarms*;
- **extensive agriculture** now has the addition of *dairy (pasture-based)* in its grouping;
- **feedlot** now includes the addition of 'fibre products';
- **food and drink premises** no longer refers to "milk bar" and references *restaurant and café* which was renamed from *restaurant*;
- **funeral home** has been amended to include facilities for memorial services, removing the need for *funeral chapel*;
- **garden centre, landscaping material supplies** and **plant nursery** are new terms which separate the growing component from supplies and garden centres that were in the superseded definition *landscape and garden supplies*. This enables them to be considered individually in different zones providing more flexibility for councils and proponents;
- **general industry** is to be used for industrial uses that are not considered to be light or heavy industry;
- **hardware and building supplies** is a renamed and amended term based on the previous *timber and building supplies* definition. **timber yards** is a stand alone land use enabling councils to consider permitting it in certain industrial or other zones if suited;
- **health consulting rooms** has been amended, removing the partnership requirements, and enabling more flexibility by having more than three health care professionals in the practice, provided only three are working at any one time to ensure impacts are in keeping with residential amenity;
- **heavy industrial storage establishment** is a new group term including *hazardous storage establishments, offensive storage establishments and liquid fuel depots*;
- **heritage conservation area** deletes the reference to *Aboriginal place of heritage significance* as Aboriginal heritage is now dealt with separately;
- **heritage item** has been amended to remove the compulsory nature of having to be identified in three places correctly in order to fulfil the criteria. The key location for heritage items is now Schedule 5, although they may still be mapped. Reference is also made to the council inventory which informed the listing;
- **heritage management document** is provided to inform users that there will be more flexibility to determine the level of analysis required to support an application where heritage is involved, and reduce costs to the applicant wherever possible;
- **high technology industry** provides for certain types of established and emerging sectors that rely on technologies that are non-polluting, meaning they may be considered suitable in a variety of zones;
- **home business, home industry, home occupation** and **home occupation (sex services)** now refer to *signage* (other than a *business identification sign for a home business*) rather than listing types of signs individually;
- **hospital** is amended to remove the term *refreshment room* and replace it with *kiosks, restaurant or café and take-away food or drink premises*;
- **industrial activity** assists in interpreting industrial related definitions. It explains the processes and activities that constitute an *industry*;
- **industrial retail outlet** now clarifies that the provisions also apply to a *rural industry*;
- **industrial training facility** is a new land use term to cover vocational training in an activity (such as forklift or truck driving) associated

with an *industry*, *rural industry*, *extractive industry* or *mining*;

- **industry** is a group term which has been revised to clarify that it includes *light industry*, *general industry* and *heavy industry*, but does not include *rural* or *extractive industries* or *mining*;
- **light industry** has been revised to clarify that it covers both a *high technology industry* and *home industry*;
- **maintenance** in relation to heritage matters now makes specific reference to *Aboriginal objects* and *Aboriginal place of heritage significance* given these terms are no longer covered by *heritage item* so they do not have to be mapped and their location detailed;
- **marina** has been amended to refer to berthing or mooring facilities, rather than any associated single mooring;
- **medical centre** has been clarified as a type of *health services facility*;
- **mooring pen** is a new land use definition to provide for the mooring or berthing of a boat, and can be used outside the application of a *marina*;
- **neighbourhood shop** has been amended to clarify that general (as opposed to specialist) merchandise can be sold where items provide for the day-to-day needs of people in the area. It is also confirmed as a type of *shop*;
- **nominated State heritage item** is a new term to assist in the interpretation of Clause 5.10(9);
- **open cut mining** and **underground mining** are new definitions recognising these different forms of mining. *open cut mining* can be used in the Land Use Table;
- **registered club** has been amended to reflect the fact clubs are now issued club licences under the *Liquor Act 2007*;
- **relic** now refers to the definition in the *Heritage Act 1977*;
- **residential accommodation** as a group term has been clarified to detail which land use terms it covers;
- **residential care facility** has been amended to clarify it does not include a *hostel*;
- **resource recovery facility** now includes composting in its definition, aligning it with that in the Infrastructure SEPP;
- **respite day care centre** is a new land use term that has been added to ensure this important use is permissible in a wide variety of zones, to provide short-term, temporary relief for carers of people with a disability or the elderly, who might

otherwise require permanent placement in a facility outside the home;

- **restaurant or cafe** has been renamed from *restaurant* and its principal purpose clarified to be the preparation and serving of food and drink on premises, to avoid confusion with *pub*. Other definitions such as *food and drink premises*, *highway service centres* and *hospitals*, which previously referenced *restaurant* have been amended to reflect this name change;
- **restricted premises** has been removed from the previous link to *business premises* and *retail premises* to avoid confusion;
- **retail premises** remains a group term but more land uses have been prescribed than was previously the case. This provides greater flexibility and opportunity for competition. It now clarifies that a *service station* is not part of the group term;
- **rural worker's dwelling** has been amended to capture a 'building or place' that is 'additional' to a dwelling house on the 'same lot' of land where *agricultural* or *rural industry* employees live, whether for short or term periods;
- **shop** now refers to the broader term 'merchandise' rather than 'general merchandise', and the hiring of this merchandise. It also includes a *neighbourhood shop*;
- **shop top housing** has had the previous wording 'or otherwise attached to' removed;
- **storage premises** now clarifies it includes *self-storage units*, but not *heavy industrial storage premises* or a *warehouse or distribution centre*;
- **telecommunications facility** has been expanded to be consistent with the Infrastructure SEPP;
- **tourist and visitor accommodation** has been clarified to specifically include *farm stay accommodation*, and exclude *camping grounds*, *caravan parks* and *eco-tourist facilities*;
- **wharf or boating facilities** is a new term that enables councils to permit facilities associated with a wharf or boating outside designated ports.

### Terms consolidated or removed

- **biosolid waste application** has been removed as it is ancillary to other uses;
- **funeral chapel** has been included in the definitions of *funeral home*, *cemetery* and *crematorium*;



- ***natural water based aquaculture, pond based aquaculture*** and ***tank-based aquaculture*** have been consolidated under the definition of *aquaculture*;
- ***waste management facility*** is removed as it is included in the definition of *waste and resource management facility*.